



Music Server



Gracenote CDDB® Client Software, copyright 2000-2006 Gracenote. This product and service may practice one or more of the following U.S. Patents: #5,987,525; #6,061,680; #6,154,773, #6,161,132, #6,230,192, #6,230,207, #6,240,459, #6,330,593, and other patents issued or pending.



Gracenote and CDDB are registered trademarks of Gracenote. The Gracenote logo and logotype, and the “Powered by Gracenote” logo are trademarks of Gracenote.

MS750 Owner's Manual

The lightning flash with arrowhead, within an equilateral triangle, is intended to alert the user to the presence of uninsulated “dangerous voltage” within the product’s enclosure that may be of sufficient magnitude to constitute a risk of electric shock to persons.



AVIS RISQUE DE CHOC ELECTRIQUE - NE PAS OUVRIR.

The exclamation point within an equilateral triangle is intended to alert the user to the presence of important operating and maintenance (servicing) instructions in the literature accompanying the appliance.

WARNING - TO REDUCE RISK OF FIRE OR ELECTRICAL SHOCK, DO NOT EXPOSE THIS EQUIPMENT TO RAIN OR MOISTURE.

NO USER-SERVICEABLE PARTS INSIDE. REFER SERVICING TO QUALIFIED PERSONNEL.

To prevent the risk of electric shock, do not remove cover or back. No user-serviceable parts inside.

CAUTION - Invisible Laser Radiation when open. DO NOT stare into the beam or view directly with optical instruments. Use of controls or adjustments or performance of procedures other than those specified in the Owners Manual may result in Hazardous Radiation Exposure.

**LUOKAN 1 LASERLAITE
KLASS 1 LASER APPARAT**

VAROITUS! Laitteen käyttäminen muulla kuin tassa käyttöohjeessa mainitulla tavalla saattaa altistaa käyttäjän turvallisuusluokan 1 ylittävälle näkymättömälle lasersäteilylle.

VARNING! Om apparaten används på annat sätt än i denna bruksanvisning specificerats, kan användaren utsättas för osynlig laserstråling, som överskrider gränsen för laserklass 1.

This product incorporates an embedded **CLASS 3B Laser (IEC60825-1).**

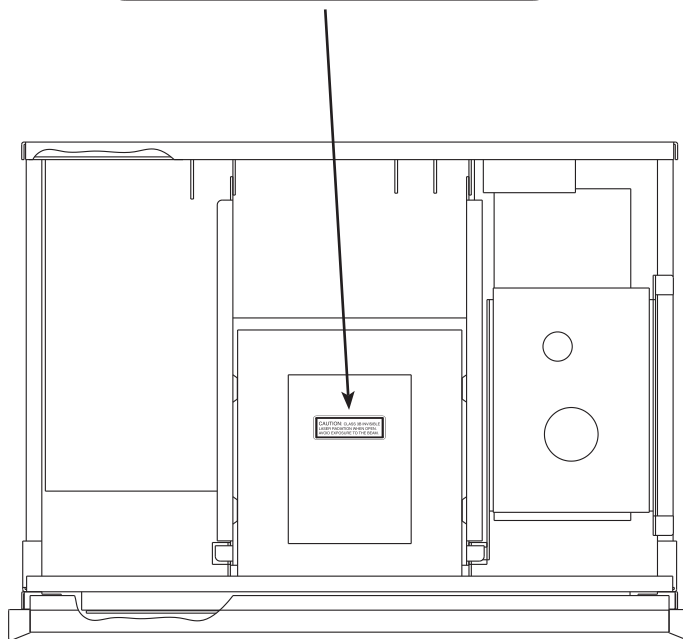
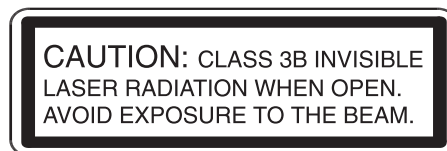

IMPORTANT SAFETY INSTRUCTIONS!

PLEASE READ THEM BEFORE OPERATING THIS EQUIPMENT.

1. Read these instructions.
2. Keep these instructions.
3. Heed all warnings.
4. Follow all instructions.
5. Do not use this apparatus near water.
6. Clean only with a dry cloth.
7. Do not block any ventilation openings. Install in accordance with the manufacturer's instructions.
8. Do not install near any heat sources such as radiators, heat registers, stoves, or other apparatus (including amplifiers) that produce heat.
9. Do not defeat the safety purpose of the polarized or grounding-type plug. A polarized plug has two blades with one wider than the other. A grounding type plug has two blades and a third grounding prong. The wide blade or the third prong are provided for your safety. If the provided plug does not fit into your outlet, consult an electrician for replacement of the obsolete outlet.
10. Protect the power cord from being walked on or pinched particularly at plugs, convenience receptacles, and the point where they exit from the apparatus.
11. Only use attachments/accessories specified by the manufacturer.
12. Use only with the cart, stand, tripod, bracket, or table specified by the manufacturer, or sold with the apparatus. When a cart is used, use caution when moving the cart/apparatus combination to avoid injury from tip-over.
13. Unplug this apparatus during lightning storms or when unused for long periods of time.
14. Refer all servicing to qualified service personnel. Servicing is required when the apparatus has been damaged in any way, such as power-supply cord or plug is damaged, liquid has been spilled or objects have fallen into the apparatus, the apparatus has been exposed to rain or moisture, does not operate normally, or has been dropped.
15. Do not expose this equipment to dripping or splashing and ensure that no objects filled with liquids, such as vases, are placed on the equipment.
16. To completely disconnect this equipment from the a.c. mains, disconnect the power supply cord plug from the a.c. receptacle.
17. The mains plug of the power supply cord shall remain readily operable.
18. Do not expose batteries to excessive heat such as sunshine, fire or the like.





Thank You

Your decision to own this McIntosh MS750 Music Server ranks you at the very top among discriminating music listeners. You now have “The Best.” The McIntosh dedication to “Quality,” is assurance that you will receive many years of musical enjoyment from this unit.

Please take a short time to read the information in this manual. We want you to be as familiar as possible with all the features and functions of your new McIntosh.

Please Take A Moment

The serial number, purchase date and McIntosh Dealer name are important to you for possible insurance claim or future service. The spaces below have been provided for you to record that information:

Serial Number: _____

Purchase Date: _____

Dealer Name: _____

Technical Assistance

If at any time you have questions about your McIntosh product, contact your McIntosh Dealer who is familiar with your McIntosh equipment and any other brands that may be part of your system. If you or your Dealer wish additional help concerning a suspected problem, you can receive technical assistance for all McIntosh products at:

McIntosh Laboratory, Inc.
2 Chambers Street
Binghamton, New York 13903
Toll Free: 866-458-6910 (9:00am - 6:00pm EST, M-F)
Phone: 607-723-3512 (8:30am - 5:00pm EST, M-F)
Fax: 607-724-0549

Customer Service

If it is determined that your McIntosh product is in need of repair, you can return it to your Dealer. You can also return it to the McIntosh Laboratory Service Department. For assistance on factory repair return procedure, contact the McIntosh Service Department at:

McIntosh Laboratory, Inc.
2 Chambers Street
Binghamton, New York 13903
Phone: 607-723-3515
Fax: 607-723-1917

Copyright 2007 © by McIntosh Laboratory, Inc.

Table of Contents

Safety Instructions	2
Thank You and Please Take a Moment.....	4
Technical Assistance and Customer Service	4
Table of Contents	4
Connector and Cable Information	5
Important Information	6
Introduction.....	7
Performance Features	7
Dimensions	8
Installation	9

Connections:

Rear Panel Connections.....	10
How to Connect the MS750	11

Front Panel Features:

Front Panel Indicators and Push-buttons	12
---	----

Remote Control:

Remote Control Push-buttons.....	14
How to Operate by Remote Control	15

Setup:

How to Operate the Setup Mode	16
Getting Disc Information.....	16-17
User Preferences	17-18
Other Modes	18
Setting Your Time Zone	18
Password Protection.....	19
Ethernet Settings.....	19
Server Settings and MS750 Music Sharing	20
Selecting the Audio Encoder Type	20
Setting the Disc Insert Preferences.....	21
Video Adjustments.....	21-23
Using a Touch Panel.....	23-24
IR Remote Control.....	24
Direct Access Codes	24
Play List Hot Push-buttons	24
Serial COM Ports.....	25
MS750 Utilities	25
Restarting the System.....	25
Updating the Software	26

Operation:

Getting Music Into the MS750.....	28-31
Erasing a CD-RW Disc.....	31
Browsing your Music Library.....	31-32
Changing Guide Views.....	32-33
Jukebox Play Modes	33-35

Table of Contents, con't

Creating Play Lists 35
 Creating Groups 36
 Internet Radio Stations 36
 Adding Internet Radio Stations 37
 Updating the Internet Radio Station List 37
 Editing Music Information 37
 Editing Track Names 38
 Searching and Selecting Covers 38-39
 Editing Radio Info, Play Lists and Groups 39-40
 Deleting Music, Play Lists, and Groups 41
 Creating CDs and a Custom Mix CD 42
 Duplicating a CD 42
 Recording from an External Source 43
 Controlling the MS750 from a Web Browser 43
 Setting up the MS750 Web Server 43
 Using the Web User Interface and Music Client 44
 MS750 Backup and Restore 44-45
 ID3 Tag Support 45
 Troubleshooting 45

Additional Information:

Specifications 50
 Packing Instruction 51

Connector and Cable Information

Power Control Connector

The MS750 Power Control Input Jack receives Power On/Off Signals when connected to other McIntosh Components. A 1/8 inch stereo mini phone plug is used for connection to the Power Control Input on the MS750.

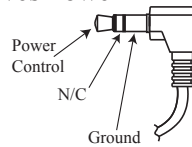

Note: The Data and Power Control Connecting Cable is available from the McIntosh Parts Department.

Data and Power Control Cable Part No. 170-202

Six foot, shielded 2 conductor, with 1/8 inch stereo mini phone plugs on each end.

Data and IR Input Port Connectors

The MS750 Data In Port receives Remote Control Signals. A 1/8 inch stereo mini phone plug is used for connection.

The IR IN Port also use a 1/8 inch stereo mini phone plug and allows the connection of other brand IR Receivers to the MS750. It also provides +12 Volts to power the external sensor.

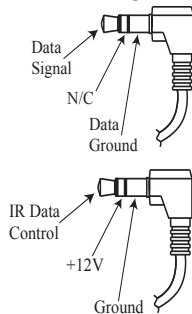

Communication Ports 1-3 (RS232 Connector Pin Out)

- 1. Carrier Detect
- 2. Receive Data
- 3. Transmit Data
- 4. Data Terminal
- 5. System Ground
- 6. Data Set Ready
- 7. Request to Send
- 8. Clear to Send
- 9. Ring Indicator

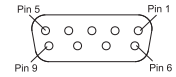

Communication Port 4 (RS232 Connector Pin Out)

- 1. Carrier Detect
- 2. Transmit Data
- 3. Receive Data
- 4. Data Terminal
- 5. System Ground
- 6. Data Set Ready
- 7. Request to Send
- 8. Clear to Send
- 9. Ring Indicator

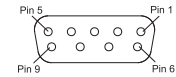

RS232 Cable - Straight Thru Connections

Pin Number	Pin Number	Pin Number	Pin Number			
1	→	1	→	6	→	6
2	→	2	→	7	→	7
3	→	3	→	8	→	8
4	→	4	→	9	→	9
5	→	5				



RS232 Cable - Null Modem Connections

Pin Number	Pin Number	Pin Number	Pin Number			
1	→	1	→	6	→	4
2	→	3	→	7	→	8
3	→	2	→	8	→	7
4	→	6	→	9	→	9
5	→	5				

Ethernet RJ45 Socket

- 1. Tranceive Data (+)
- 2. Tranceive Data (-)
- 3. Receive Data (+)
- 4. N/C
- 5. N/C
- 6. Receive Data (-)
- 7. N/C
- 8. N/C

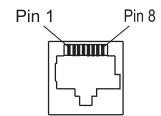

Ethernet Cable - Straight Thru Connections

Pin Number - Wire Color	Pin Number - Wire Color	
1. Orange/White	→	1. Orange/White
2. Orange	→	2. Orange
3. Green/White	→	3. Green/White
4. Blue	→	4. Blue
5. Blue/White	→	5. Blue/White
6. Green	→	6. Green
7. Brown/White	→	7. Brown/White
8. Brown	→	8. Brown



Ethernet Cable - Crossover Connections

Pin Number - Wire Color	Pin Number - Wire Color	
1. Orange/White	→	1. Green/White
2. Orange	→	2. Green
3. Green/White	→	3. Orange/White
4. Blue	→	4. Blue
5. Blue/White	→	5. Blue/White
6. Green	→	6. Orange
7. Brown/White	→	7. Brown/White
8. Brown	→	8. Brown

Important Information

- For additional connection information, refer to the owner's manual(s) for any component(s) connected to the MS750 Music Server.
- The MS750 Music Server will play all standard CD Audio Discs that conform to the Official Compact Disc Standards which is indicated by the Symbol .
- The MS750 requires Connection to the Internet for the MS750 to be registered and authenticated. The built-in Gracenote Program also requires the Internet for looking up the Album Title, Track Name, and Track Playing Time of the music and display it.
- The MS750 IR IN jack is configured for non-McIntosh IR sensors such as Xantech Model 291-80 or other compatible sensor.
- When connecting external CD Changers to the MS750 there are two possible communication connection types, S-Link and RS232 Com Port. These connections allow the MS750 to control the changers. Refer to the Owner's Manual supplied with the changer to determine which connection type(s) and the correct cable types to use. At the time of the printing of this Owner's Manual the Sony DVP-CX777ES changer is known to be compatible with the MS750.
- The MS750 may be controlled by an external Touch Screen Panel from the following companies:
 - AMX
 - Crestron
 - Elan Via
 - Home Theater Master
 - Lexicon
 - Marantz
 - Net Streams
 - Opus
 - Phillips Pronto
 - RTI
 - Sonance
 - Xantech
- The Ethernet Connector on the MS750 allows for connection to a computer network for accessing the Internet and adding a second MS750 to the Audio/Video System. If there is no computer network available, an external modem may be connected to the MS750 for access to the Internet. In both cases, please refer to Owner's Manuals supplied with the external equipment to be connected to the MS750 for the correct cable types. On page 5 of this manual there is information on different cable types.
- The MS750 basic transport functions may also be controlled by using the Remote Control that comes with a McIntosh Control Center or Preamplifier. McIntosh Keypads can also be used to remotely control the basic transport functions of the MS750. Remote Controls of certain McIntosh Control Centers or Preamplifiers also have additional Push-buttons including Direction Keys, Select, Title, Display and Menu that perform the same functions as the supplied MS750 Remote Control. The

labeling of Push-buttons on some McIntosh Remote Controls and Keypads are different from the supplied MS750 Remote Control. Refer to the following listing and illustrations:

<i>MS750 Remote Control</i>	<i>Control Center/Preamp/Keypad</i>
Directional (▲▼◀▶)	Directional (▲▼◀▶)
0-9	0-9
Play ▶	Play ▶
Stop ■	Stop ■
Pause	E
Fast Forward ▶▶	Fast Forward ▲
Reverse ◀◀	Reverse ▼
Ch ▲	Channel Up ▲
Ch ▼	Channel Down ▼
Option	Title
Select	Select
Guide	Display
Menu	Menu

McIntosh Remote Controls for A/V Control Centers and Preamplifiers

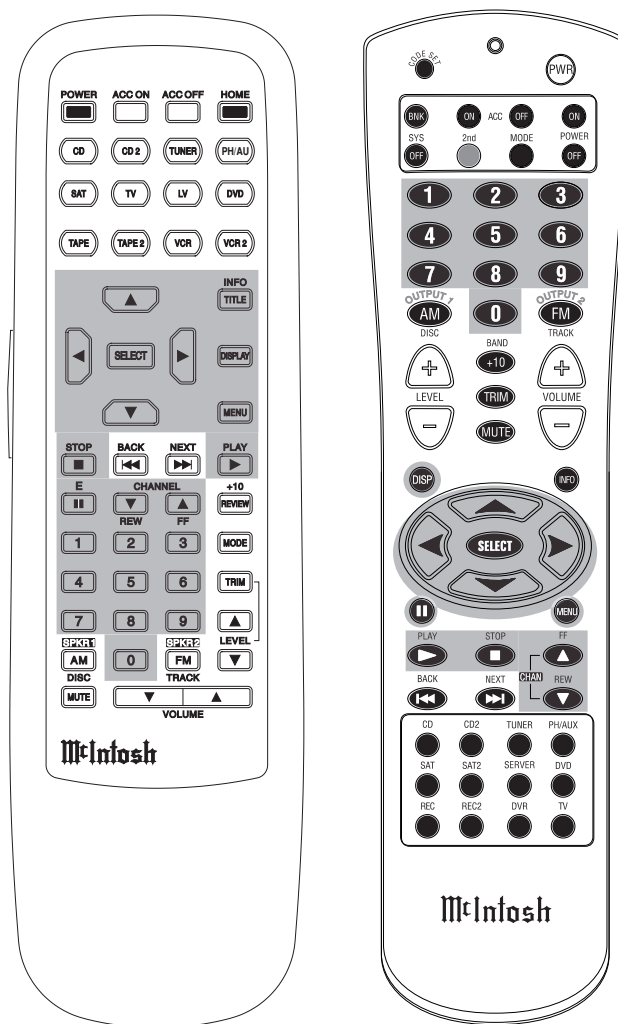

Introduction

The McIntosh MS750 Music Server offers the latest in audio technology, providing state of the art audio reproduction with the convenience of instant access to your music library. When the MS750 is added to a McIntosh Multi-zone System, the music from this source may be enjoyed in any part of your home. The advanced design ensures many years of smooth trouble free operation.

Performance Features

• High Storage Capacity

The MS750 incorporates a massive 750GB Hard Drive capable of storing the contents of a large CD Music Collection.

• CD Record and Playback Transport

The MS750 has a new advanced transport for fast, quiet and accurate operation. Transfer music from a CD to the internal hard drive in less than 5 minutes.

• Graphical User Interface

When connected to a TV/Monitor, the On Screen Display provides information such as Album Name, Artist Name, Song Name, Playing Time and Location for each of the selections. This allows for easy song selection from multiple rooms in your home.

• Automatic CD Identification

When the MS750 is connected to the Internet, it will automatically look-up information on the loaded CD. This includes Album Name, Artist Name, Song Name and Playing Time. This information is then stored internally for later recall.

• Multiple Video Outputs

The MS750 has Component Video Output, S-Video Outputs and Composite Video Outputs for a variety of applications.

• Internet Radio Stations

The MS750 also allows for listening to Internet Radio Stations when connected.

• Select your Music

Listen to the music you want by creating your own play lists and/or groups of music types. Take the music with you by recording CDs from your favorite play lists and/or groups.

• Expand the Music Server System

Multiple MS750s may be connected together with access to any two MS750s at one time. This provides for unlimited music storage capacity.

• Digital Audio Inputs and Outputs

There are Coaxial and Optical Digital Audio Inputs/Outputs for connection to other components.

• Alphanumeric Fluorescent Display

The display on the MS750 Front Panel provides various information on the operating status and the current music playing.

• On Screen Setup

The On Screen Setup allows for customizing various settings such as audio, video, network and external control to match the components in your system.

• Power Control

The Power Control Input connection provides convenient Turn-On/Off of the MS750 when connected to a McIntosh System with Power Control.

• Remote Control

The Remote Control with illuminated push-buttons, provides control of the MS750 operating functions. A Data Port Connection to a McIntosh A/V Control Center or Preamplifier allows for convenient system operation using one Remote Control. An External IR Sensor Input allows for remote operation when the MS750 is located behind closed doors.

• Special Power Supply

A fully regulated Power Supply ensures stable noise free operation even though the power line varies.

• Machined Side Panels

The sides of the MS750 are machined from thick aluminum panels with a smooth black finish.

• Fiber Optic Solid State Front Panel Illumination

The Illumination of the Glass Front Panel is accomplished by the combination of custom designed Fiber Optic Light Diffusers and extra long life Light Emitting Diodes (LEDs). This provides even Front Panel Illumination and is designed to ensure the pristine beauty of the MS750 will be retained for many years.



Dimensions

The following dimensions can assist in determining the best location for your MS750. There is additional information on the next page pertaining to installing the MS750 into cabinets.

Front View of the MS750

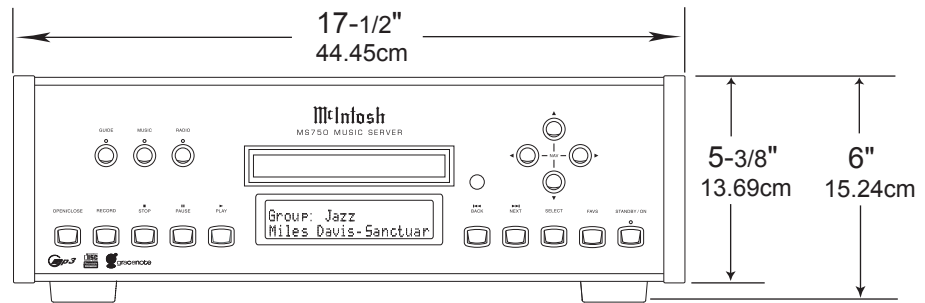

Rear View of the MS750

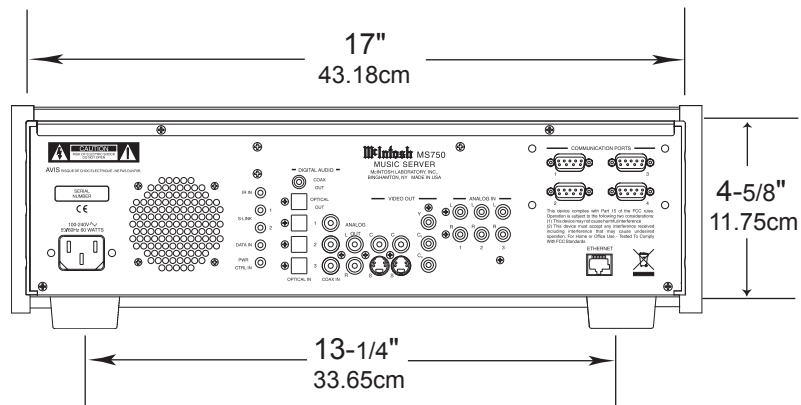

Side View of the MS750

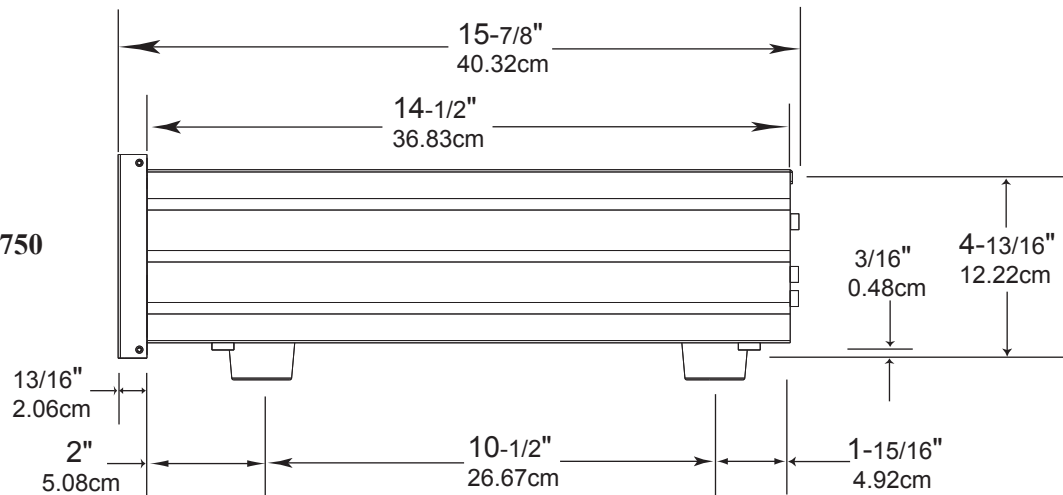

Installation

The MS750 can be placed upright on a table or shelf, standing on its four feet. It also can be custom installed in a piece of furniture or cabinet of your choice. The four feet may be removed from the bottom of the MS750 when it is custom installed as outlined below. The four feet together with the mounting screws should be retained for possible future use if the MS750 is removed from the custom installation and used free standing. The required panel cutout, ventilation cutout and unit dimensions are shown.

Always provide adequate ventilation for your MS750. Cool operation ensures the longest possible operating life for any electronic instrument. Do not install the MS750 directly above a heat generating component such as a high powered amplifier. If all the components are installed in a single cabinet, a quiet running ventilation fan can be a definite asset in maintaining all the system components at the coolest possible operating temperature.

A custom cabinet installation should provide the following minimum spacing dimensions for cool operation.

Allow at least 2 inches (5.08cm) above the top, 2 inches (5.08cm) below the bottom, 1 inch (2.54cm) on each side and 2 inches (5.08cm) behind the Music Server, so that airflow is not obstructed.

Do not block the ventilation holes on the top cover, bottom cover and rear panel. Allow 1 inch (2.54 cm) in front of the mounting panel for clearance. When the CD tray is opened, the panel clearance required in front of mounting panel is 6-3/4 inches (17.2cm). Be sure to cut out a ventilation hole in the mounting shelf according to the dimensions in the drawing.

**MS750 Front Panel
Custom Cabinet Cutout**

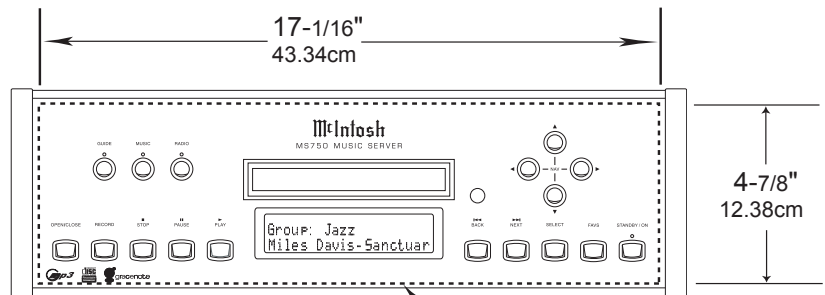

Cutout Opening for Custom Mounting

**MS750 Side View
in Custom Cabinet**

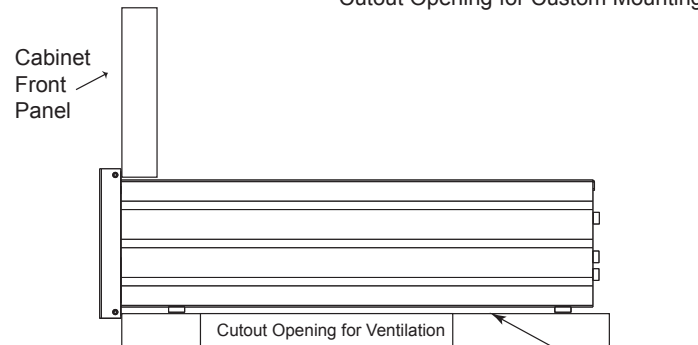

**MS750 Bottom View
in Custom Cabinet**

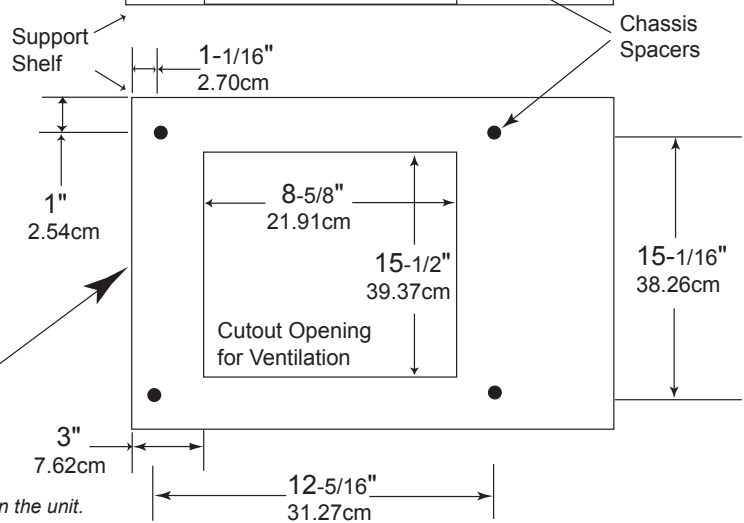

Note: Center the cutout horizontally on the unit.
For purposes of clarity, the above illustration is not drawn to scale.



S-LINK sends operating data to external CD Changers

COAXIAL and OPTICAL DIGITAL AUDIO OUTPUTS send signals to a Control Center with a D/A Converter or a decoder

COMPOSITE VIDEO OUTPUTS supply video signals to a Composite Input of an A/V Control Center or other video component

RS-232C connector for connection to control CD Changers

IR Input for connecting an IR Receiver

ANALOG AUDIO OUTPUT connects to the Analog Input of an A/V Control Center

ANALOG AUDIO INPUTS connect to external CD Changer Audio Outputs

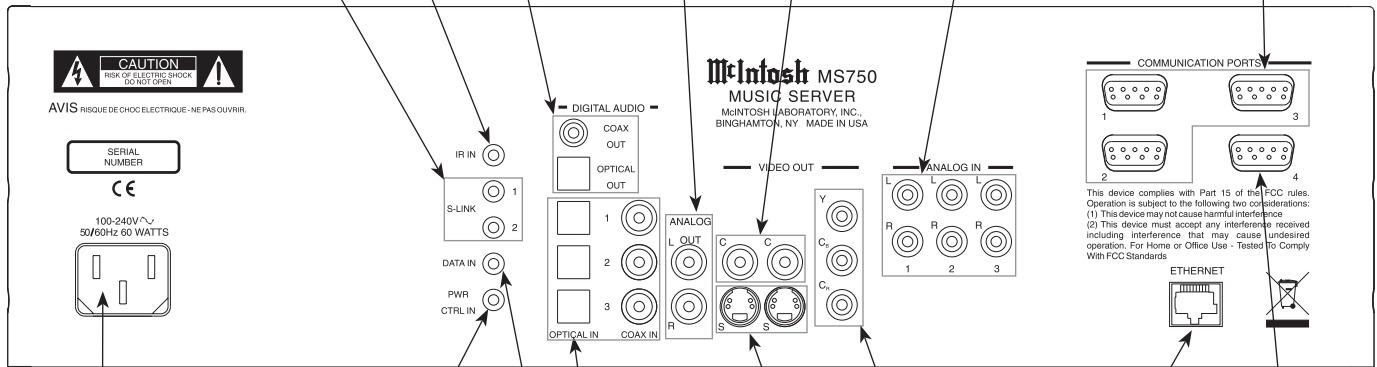

Connect the MS750 power cord to a live AC outlet. Refer to information on the rear panel to determine the correct voltage for your unit

DATA IN receives operating data from a McIntosh Control Center

S-VIDEO OUTPUTS supply video signals to a S-Video Input of an A/V Control Center or other video component

ETHERNET Network Connector for connecting the MS750 to a Broadband Ethernet Network

POWER CONTROL IN receives turn-on signals from a McIntosh component

OPTICAL and COAXIAL DIGITAL AUDIO INPUTS receive signals from external CD Changers

Y OUTPUT connects to the Y Component Input of the TV/Monitor or other video component. P_B/C_B OUTPUT connects to the P_B/C_B Component Input of the TV/Monitor or other video component. P_R/C_R OUTPUT connects to the P_R/C_R Component Input of the TV/Monitor or other video component

RS-232C connector for connection to a remote control device

How to Connect the MS750

The MS750 has the ability to automatically switch On/Off when connected to a McIntosh A/V Control Center or Preamplifier via the Power Control Connections. The Data Port Connections allow for the remote operation of basic functions of the MS750 using the McIntosh A/V Control Center or Preamplifier Remote Control. With an External Sensor or External Touch Panel connected to the MS750, remote control operation is possible when the MS750 is located in a cabinet with the doors closed or from another room.

The connection instructions below, together with the Connection Diagram located on the separate folded sheet “Mc1A/1B”, is an example of the MS750 in a typical audio/video system. Your system may vary from this, however the actual components would be connected in a similar manner. It is important to connect both the Digital and Analog Audio connections between the MS750 and any external disc changer as no internal conversion takes place.

For additional information refer to “Connector and Cable Information” on page 5.

Power Control Connection:

1. Connect a Control Cable from the MS750 POWER CTRL(Control) IN Jack to the Power Control Out (ACC) jack on the McIntosh A/V Control Center or Preamplifier.

Data Control Connection:

2. Connect a Control Cable from the MS750 DATA IN Jack to the McIntosh A/V Control Center or Preamplifier CD2 or CDR Data In Jack.

Sensor Connection:

3. Optionally connect an external sensor to the MS750 IR jack. Refer to page 6 “Important Information” note number 4 for additional information.

S-Link Connection:

4. Optionally connect a appropriate cable from the MS750 S-LINK 1 jack to the first external CD Changer S-Link jack. In a like manner, connect a second CD Changer to MS750 S-Link 2. Refer to page 6 “Important Information” note number 5 for additional information.

RS-232 Connection:

5. Optionally connect a “null modem” cable from the MS750 COMMUNICATION PORT1 connector to the first external CD Changer RS-232 connector. In a like manner, connect a second and/or third CD Changer to MS750 COMMUNICATION PORTS 2 and 3 respectively. Refer to page 6 “Important Information” note number 5 for additional information.

Ethernet Connection:

6. Optionally connect an appropriate cable from the MS750 ETHERNET connector to an Ethernet based network (Hub, Switch, or Router). If no network is available, a modem may be connected to the MS750 for downloading disc information (Titles, Track Names and Times) and access to Internet Radio Stations. Refer to page 6 “Important Information” note number 6 for additional information.

External Touch Panel Connection:

7. Optionally connect an appropriate cable from the MS750 COMMUNICATION PORT4 connector to an External Touch Panel Control Base.

Audio Connections:

8. Connect an Audio Cable from the MS750 ANALOG OUTPUT Jacks to the McIntosh A/V Control Center or Preamplifier CD2 or CDR Input Jacks.
9. Optionally connect a Coaxial or Optical Cable from the MS750 DIGITAL AUDIO COAXIAL OUT or OPTICAL OUT Connectors to the McIntosh CD2 or CDR Coaxial or Optical Input connector.
10. Optionally connect an Audio Cable from the MS750 ANALOG IN 1 jacks to the first external CD Changer Audio Output. In a like manner, connect a second and/or third CD Changer to the MS750 ANALOG IN 2 and 3 jacks respectively.
11. Optionally connect an Coaxial or Optical Cable from the MS750 DIGITAL AUDIO COAXIAL or OPTICAL IN 1 connector to the first external CD Changer Coaxial or Optical Audio Output. In a like manner, connect a second and/or third CD Changer to the MS750 DIGITAL AUDIO COAXIAL or OPTICAL IN 2 and 3 connectors respectively.

Video Connections:

12. Connect a Video Cable(s) from the MS750 VIDEO OUT (Component Video, S-Video and/or Composite Video) Jack to the McIntosh A/V Control Center or TV/Monitor (Component Video, S-Video and/or Composite Video) Input Jacks.

Note: The Component Video Input used may require reassignment to the CD2 Input.

13. Optionally connect a Video Cable(s) from the MS750 VIDEO OUT (Component Video, S-Video and/or Composite Video) Jacks to the External Touch Panel Control Base.

AC Power Cords Connections:

14. Connect the MS750 AC Power Cord to a live AC outlet.
15. Connect the remaining components’ AC Power Cords.



Front Panel Displays and Push-buttons

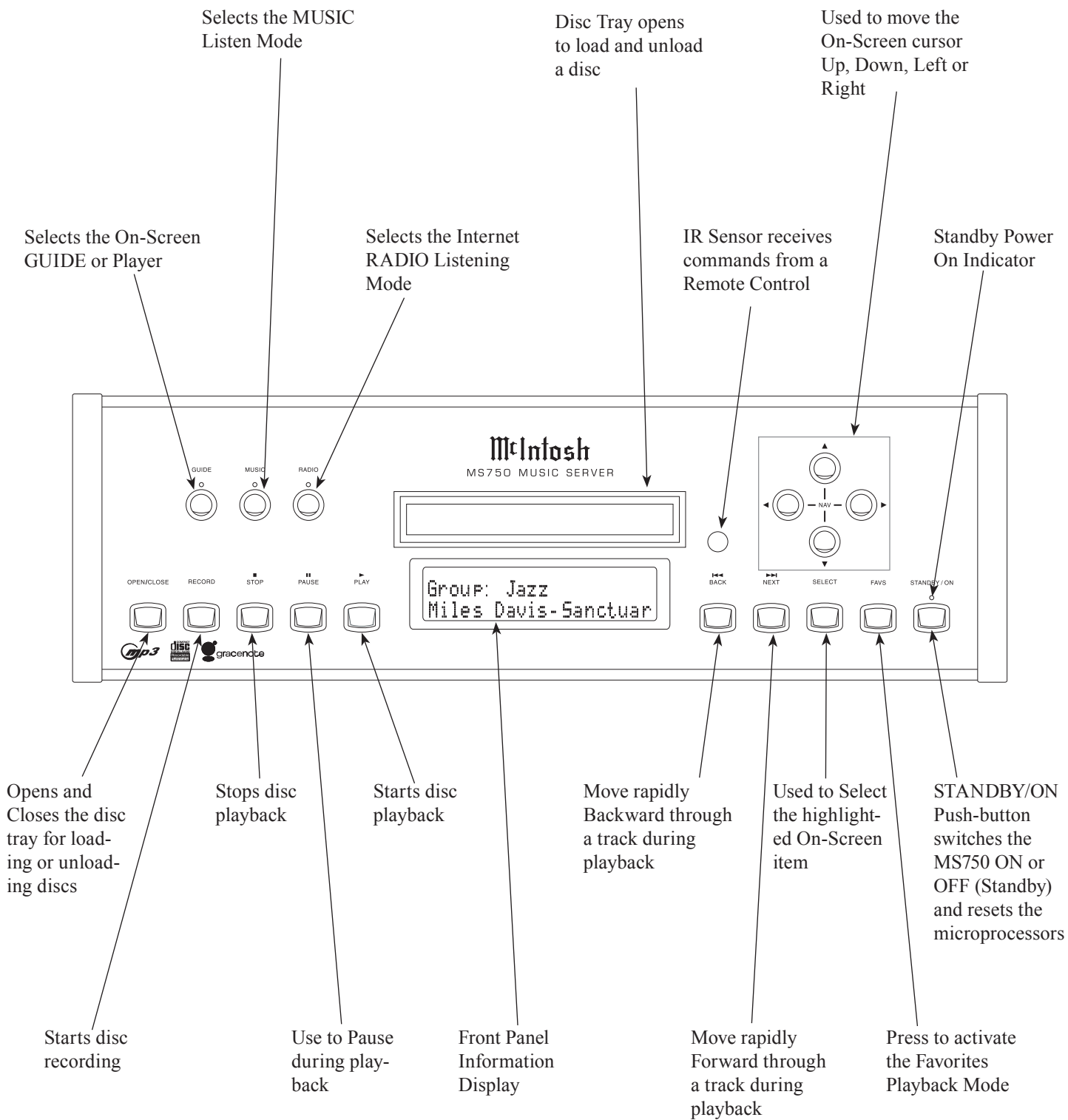





Press first to send operational commands to the first MS750 Music Server

Press first to send operational command to the second, third or fourth MS750 Music Servers

Press first to send operational command to a McIntosh Sound System

Access any numbered and text based operating function

Mutes the audio of a McIntosh Sound System*

Press to select various option modes of operation

Adjusts the volume level up or down of a McIntosh Sound System*

Activates the On-Screen Guide or Player Screens

Use to move the on-screen cursor up, down, left, right; also use to select the highlighted On-Screen item

Press to display various disc information. It is displayed On-Screen and on the Front Panel Alphanumeric Display

Starts Playback and allows moving fast forward or reverse within the track playing

Activates various Record Mode Functions

Press to activate the Internet Radio Listening Mode

Press to activate the Music Listening Mode

Press to return to the previous selection

Press to add the selected item to the Favorites Play List or Jukebox Queue when enabled

Use to toggle the power On and Off to the MS750

Press to enter the previously pressed push-button (0-9, A-Z or symbols)

Press to access various music play modes such as Normal, Random and Repeat

Press to change the Channel, Up or Down; also used to page Up or Down through various On-Screen Displays

Press to access the MS750 Setup Mode

Press to access various On-Screen Guide views

Press to access various On-Screen Menus

Use to stop or pause the music playback

Press to access various Repeat Playback Modes

Press to advance to the next selection

Press to select various Random Playback Modes

Press to start playback of the selected Favorites or Jukebox Music when enabled

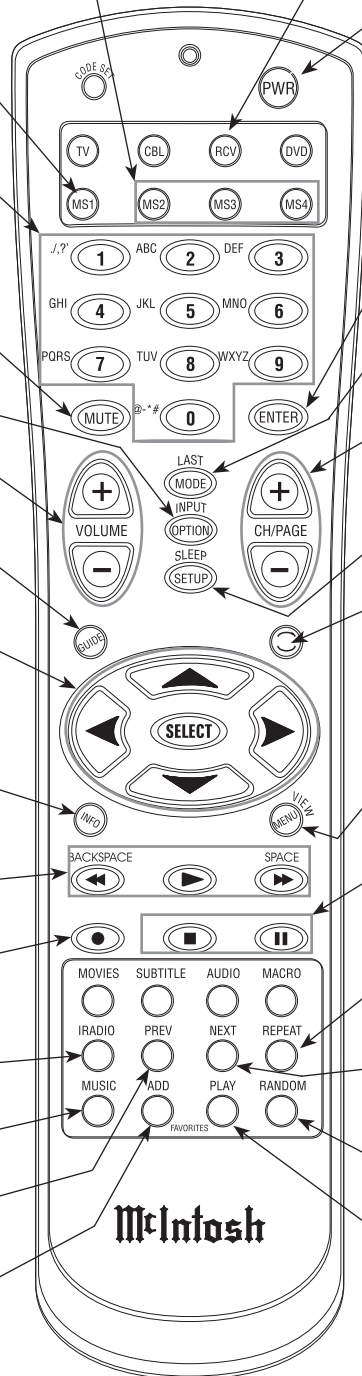

Notes: Push-buttons whose function is not identified above are for use with other McIntosh Components. * The McIntosh System Volume Up/Down and Muting push-button functions require first pressing the RCV Push-button. To return to normal MS750 Remote Control functions first press the MS1 Push-button.

How to use the Remote Control

The Remote Control is capable of performing both basic Operating Functions and Setup Options for the MS750 Music Server.

Notes: Refer to the “How to Operate” and “How to Operate Setup Mode” Sections of this manual for additional information using this Remote Control.

Device Selection

This Remote Control is used to operate the McIntosh MS750 Music Server and the Volume Level/Mute functions of McIntosh Audio/Video Control Centers and Preamplifiers. When using the Remote Control with the MS750, first press the MS1 push-button and then press the push-button for the desired function. It is only required to press the MS1 push-button once, unless the Remote Control is also being used to control a McIntosh Audio/Video Control Center or Preamplifiers.

When the Remote Control is being used to control the Volume Level/Mute of McIntosh Audio/Video Control Centers and Preamplifiers both McIntosh Components, first press the RCV push-button and then the Volume Up/Down or Mute push-button(s).

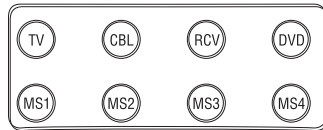

Play

Press the PLAY ► push-button to start playback of the desired music selection.

Stop

Press the STOP ■ Push-button to stop music playback.

Numbered/Symbol Push-buttons

Press 0 through 9 Push-button(s) to access the desired music selection, followed by pressing the SELECT Push-button.

The text names of Albums/Tracks may be entered manually by pressing the OPTIONS Push-button. Select from the Options Menu “Edit Disc Info”. Enter the first character of the name by selecting the appropriate push-button and then press the push-button once for the first character in upper case. Repeated rapid presses of the same push-button will scroll through the other upper case characters assigned to the push-button followed by lower case versions of the same characters. Finally the numeric number of the push-button will appear, followed by repeating of the same order again. Use the BACKSPACE / SPACE Push-buttons for the necessary spaces between words and/or to make corrections.

Pause

Press the PAUSE || Push-button to temporarily stop the music playback.

Previous and Next

Press the NEXT Push-button to move forward or the PREVIOUS Push-button to move backward one selection at a time.

Backspace and Space

Press a BACKSPACE (Reverse)◀◀ or SPACE (Forward)▶▶ Push-button to start moving rapidly through music selections. Also used during the manual entering of text names of Albums/Tracks. Press the BACKSPACE Push-button to move the cursor to the left or press the SPACE Push-button to move the cursor to the right.

Option

Press the OPTION Push-button to access the On-Screen Option Menu.

Setup

Press the SETUP Push-button to access the Initial Setup Menu.

Mode

Press the MODE Push-button to select one of three different Music Repeat Modes or two different Random Music Modes.

Four Direction Arrows

Press an Arrow direction Push-button to move Backward, Forward, Up or Down through an On-Screen Menu.

Select

Press the SELECT Push-button to confirm and activate a setup option or options indicated by the on-screen icons.



How to Operate the Setup Mode

Your McIntosh MS750 has been factory configured for default operating settings that will allow you to immediately enjoy superb audio. If you wish to make changes to the factory default settings, a Setup feature is provided to customize the operating settings using the On-Screen Display (OSD) Menus.

Notes: The MS750 must be connected to a MONITOR/TV either through an A/V Control Center or directly, for setup and use.

The Red LED above the STANDBY/ON switch lights to indicate the MS750 is in Standby mode. To Switch ON the MS750, press the STANDBY/ON Push-button on the Front Panel or press the PWR(Power) Push-button on the Remote Control.

Notes: 1. When AC

Power is initially applied to the MS750 the LED located above the STANDBY/ON Push-button will flash red until the start up process is complete and then go into the Standby Mode. Please wait as this may take several minutes. Refer to the separate, folded sheet "MCIA/IB" for additional start up information.

- 2. If power is removed from the MS750 for any reason, including a power outage or if the unit is unplugged, the MS750 will automatically return to the Standby state as soon as power is restored. When it is turned on again, the MS750 will return to the same source mode that it was in when power was lost.*
- 3. If the MS750 becomes unresponsive, PRESS and HOLD the STANDBY/ON Push-button on the Front Panel of the unit for 4 seconds, releasing when the standby LED starts blinking.*

Automatically Getting Disc Information

Once your changers are connected to the MS750 and loaded with CDs, all you have to do is close the changer door and in a few seconds the MS750 will begin looking up the disc information from each disc, in each changer.

Quick Lookup checks each previously empty slot in the changers to see if any new discs were added, and then checks each previously occupied slot in the changer to see if any discs were removed.

One by one, the Table of Contents is read from each CD and compared to the Gracenote CDDDB® using your Internet connection, as the MS750 builds your Music Library. As each disc is accessed and looked up, the Quick Lookup screen is updated to display the disc's information and

cover art. When all of the discs are looked up, the Guide screen will be displayed.

You can manually run Quick Lookup at any time by following these steps:

1. Press the SETUP push-button on the remote to display the Setup menu. Refer to figure 1.
2. Select the Changer Management menu. Refer to figure 2.
3. Select the Look-up Discs menu.
4. Select the Quick Lookup menu.
5. The MS750 will perform a Quick Lookup for each new disc.

Warning:

Quick Lookup checks for newly added and removed CDs each time it runs. Do not remove CDs and replace new CDs into the same changer slots without running Quick Lookup in-between, or the MS750 will not know that these slots have changed. If you want to reuse the same slots, first remove your DVD/CDs, let Quick Lookup run, then add new DVD/CDs to the same slots.

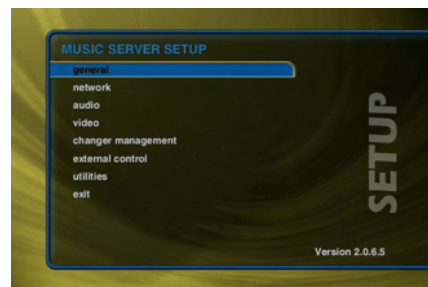

Figure 1



Figure 2

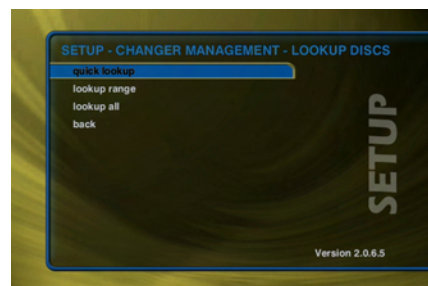
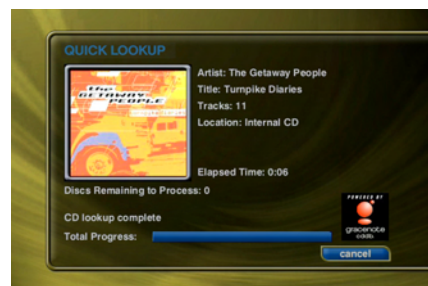

Figure 3



Getting Disc Information for a Range of Discs

If you want to lookup the disc information for a specific range of slots in a changer, you can use the Lookup Range feature. Follow these steps to lookup a range of changer slots:

1. Press the SETUP push-button on the remote to display the Setup menu. Refer to figure 1.
2. Select the Changer Management menu. Refer to figure 2.
3. Select the Lookup Discs menu.
4. Select the Lookup Range menu.
5. Enter a valid range of slots to lookup. If you have more than 1 changer, select which changer you want to use.
6. Select the CONTINUE button.
7. The Lookup Range screen displays the progress and results for each disc in the selected range.

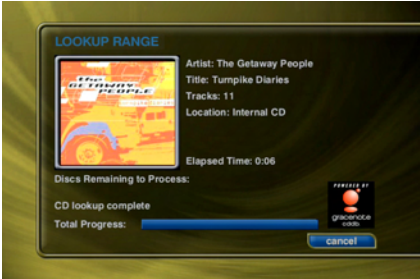
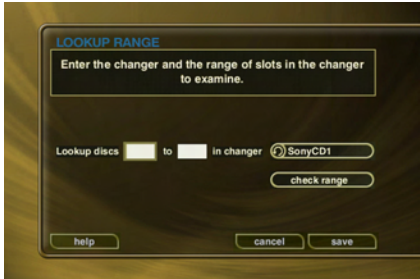

Getting Disc Information for All Discs

If you want to lookup the disc information for all discs in all changers, you can use the Lookup All feature. Follow these steps to lookup all discs in all changers:

1. Press the SETUP push-button on the remote to display the Setup menu. Refer to figure 1.
2. Select the Changer Management menu. Refer to figure 2.
3. Select the Lookup Discs menu.
4. Select the Lookup All menu.
5. The Lookup All screen displays the progress and results as each disc in each changer is looked up.

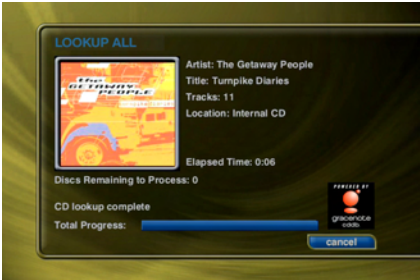
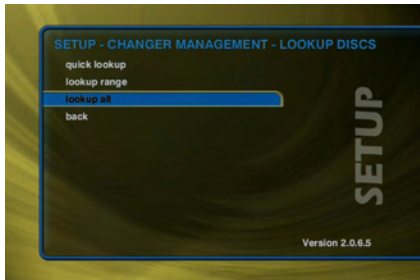

Setting User Preferences

User preferences are available to specify global configuration options and preferred system settings. Press

the SETUP push-button on the remote control to display the Setup Menu. Use the navigation push-buttons on the remote control (up, down, left, and right) to highlight and select any menu item.

Selecting Your Language

The MS750 supports 5 different languages for its on screen menus and text. Follow these steps to set the language of your choice: Refer to figure 1.

1. Press the SETUP push-button on the remote to display the Setup Menu.
2. Select the GENERAL menu item.
3. Select the LANGUAGE menu item.
4. Select the desired language.



Setting the Screen Saver Preferences

Screen Savers are provided for each source mode. Screen Savers provide two important functions, to prevent a static image from being displayed on the video output device for extended periods of time and to provide useful information to the user when activated. Follow these steps to set your screen saver preferences:

1. Press the SETUP push-button on the remote to display the Setup menu.
2. Select the General Menu. Refer to figure 1.
3. Select the Screen Saver Menu.
4. Select your Screen Saver Preferences.

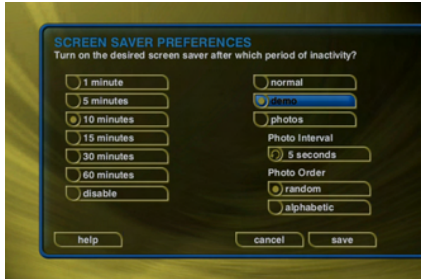

Activation Idle Time

You can specify the amount of idle time the MS750 will wait before activating the screen saver from 1 to 60 minutes.

Warning: Some televisions and plasma monitors are more susceptible to screen burn-in than others, therefore, we recommend using a low activation time (like 1 minute) to reduce the risk of burn-in.

Notes: The RDM will be activated whenever the MS750 is idle for the specified period of time. Do not set the idle time too high as the possibility of screen burn is increased with certain types of displays, particularly "Plasma" type displays.

Other Modes

Select either the Normal, Product Demo, or Photo Viewer mode. The Normal mode displays the current title or station information while the Product Demonstration mode is intended for retail product demos during idle time. Photo Viewer displays photos located in the "/Photos" folder on the internal Hard Drive. Refer to page 30 for additional information.

Retail Demo Mode

The MS750 has a Retail Demo Mode for use in retail display environments. The Retail Demo Mode (RDM) is a special screen saver that is activated during idle time. The RDM continuously displays push-button features and benefits of the MS750 product on the attached TV. Pressing any button on the remote will temporarily disable the RDM and allow the user to demo the product. After the specified idle time, the RDM will reactivate as the screensaver. Follow these steps to enable the Retail Demo Mode in your MS750 display model:

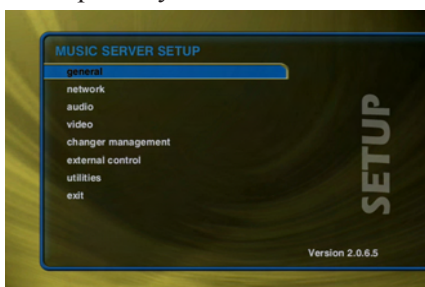

Figure 1

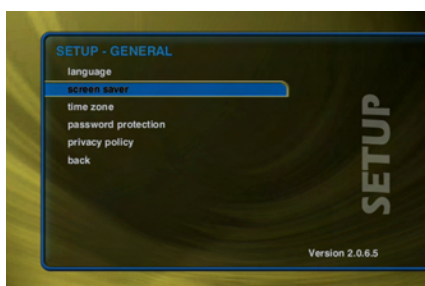

Figure 2

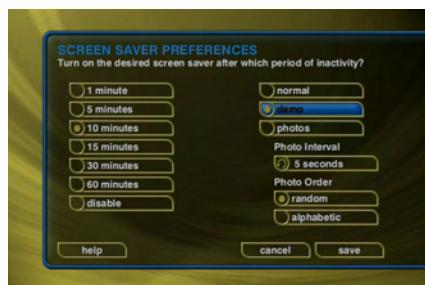

Figure 3

1. When your MS750 is configured and you see the Music Guide, press the SETUP push-button on the remote.
2. Select the General menu.
3. Select the Screen Saver menu.
4. Select the Demo Mode option and the number of minutes to wait before displaying the Demo Mode screen saver.
5. Select the Save button.

Photo Screen Saver Mode

The MS750 has a Photo Screen Saver Mode for displaying your own photos whenever the MS750 is idle for a specified period of time. You can import your own photos into the Photos shared directory using Windows Networking. Photos should be 720x480 for 4:3 NTSC TVs and 640x360 for 16:9 widescreen TVs. Follow these steps to enable the Photo Screen Saver Mode in your MS750:

1. Press the SETUP push-button on the remote. Refer to figure 1.
2. Select the General menu.
3. Select the Screen Saver menu. Refer to figure 2.
4. Select the Photo Viewer option and the number of minutes to wait before displaying the next photo.
5. Select Random or Alphabetical ordering.
6. Select the Save button.

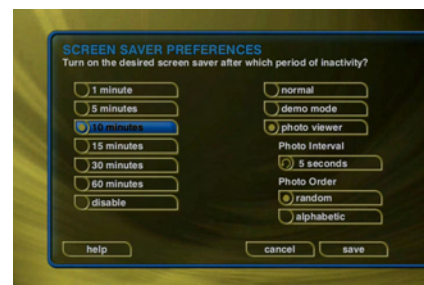

Notes: You can

set the Photo Interval or how long each photo is displayed as well as the Photo Order or how you want to display your photos, in random or alphabetical order. The Photos Screen Saver will be activated whenever the MS750 is idle for the specified period of time. Do not set the idle time too high as the possibility of screen burn is increased with certain types of displays, particularly "Plasma" type displays.

Setting Your Time Zone

Specify which time zone your MS750 is located in. Follow these steps to set your Time Zone:

1. Press the SETUP push-button on the remote to display the Setup menu.
2. Select the General Menu. Refer to figure 1.
3. Select the Time Zone Menu. Refer to figure 2.
4. Select your select your Time Zone.



Enabling Password Protection

Optional Password Protection enables you to limit user access to the Setup Menus. This is useful to lockout the ability to change the global user settings and preferences.

Setting a System Password.

Follow these steps to setup a new system password:

1. Press the SETUP push-button on the remote.
2. Select the General menu. Refer to figure 1.
3. Select password protection.
4. Using the remote control, enter a 4 to 8 digit code into the password field.
5. Press the SELECT push-button to highlight the VERIFY field.
6. Re-enter the same password for verification.
7. Press the SELECT push-button to highlight the SAVE button.
8. Press SELECT again to save your password and enable Password Protection on the Setup Menus.

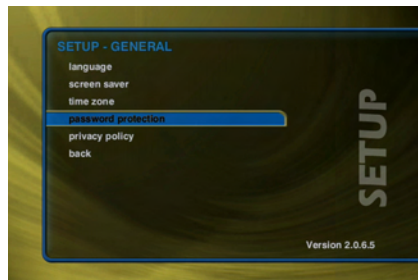

- Notes:*
1. You must exit Setup and re-enter setup to activate the password protection.
 2. If a user password is specified, you will be prompted for your password whenever you press the Setup push-button on the remote.
 3. If the password entered matches the stored password, full access is granted to the user until the next power off cycle.
 4. If the password does not match, the user will be asked 2 more times to enter the correct password. If after the third try the password still does not match, the system will not allow the user access to the Setup menus.
 5. If the user does not specify a System Password, access to the Setup menus will be allowed whenever you press the Setup push-button.

Removing a System Password

Follow these steps to remove the system password:

1. Press the SETUP push-button and enter your existing system password.

2. Highlight the CLEAR button on screen and press the SELECT push-button on your remote.
3. The password and verify fields will be cleared.
4. Highlight the SAVE button and press SELECT.
5. You will now be able to enter Setup without entering a password.

Ethernet Settings

Ethernet is the preferred networking choice which provides you with the best network performance and allows your MS750 to act as a “server” to deliver your music collection throughout your home network using the optional MS750 Music Players.

Ethernet networks require that you configure each device on the network with a valid “address”. These addresses are usually configured automatically by your network hardware. If your PC is setup using Dynamic or “DHCP” addressing, you should most likely use the same for your MS750.

Connect your MS750 to your Ethernet network using the included Ethernet cable and then follow these steps to specify your Ethernet settings:

1. Press the SETUP push-button on the remote to display the Setup menu. Refer to figure 1.
2. Select the Network Menu. Refer to figure 4.
3. Select the Ethernet Settings Menu.
4. Select Dynamic for automatic address configuration or Static if you want to manually enter your TCP/IP address information.

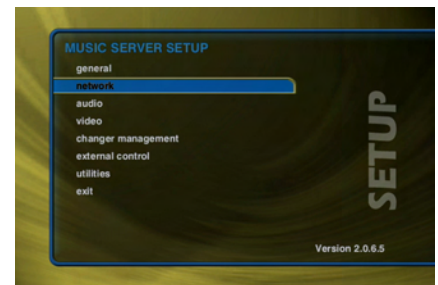

Figure 1

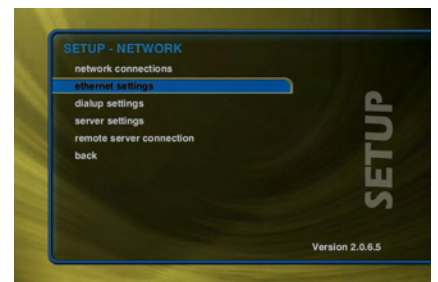
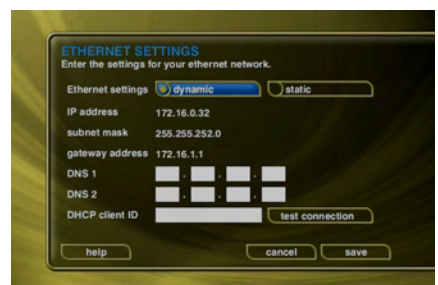

Figure 4



Note: If you select Static TCP/IP addressing, you will need to obtain a valid IP address, subnet mask, DNS server, and gateway addresses from your network administrator.

Server Settings

Your MS750 can act as a “server” delivering audio to optional MS750 “clients” over the network. MS750’s server also allows you to control it remotely using a web browser on your PC and allows Network File Sharing for backup and import features. The MS750 Name allows you to easily locate and connect to your MS750 by name.

Follow these steps to enter a name for your MS750:

1. Press the SETUP push-button on the remote to display the Setup menu. Refer to figure 1.
2. Select the Network menu. Refer to figure 4.
3. Select the MS750 Server SETTINGS menu.
4. Enter a name for your MS750 using the remote control. For example: “Living Room” or “Home Theater” might be a name which helps identify which MS750 you want to connect to.

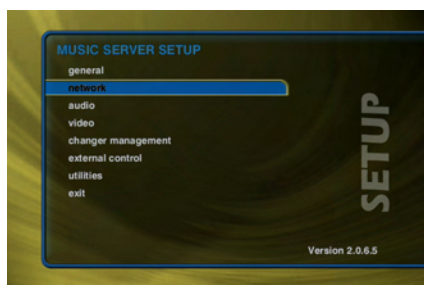

Figure 1

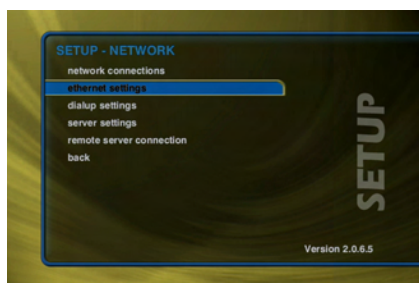
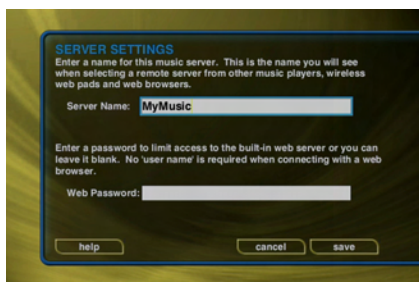

Figure 4



Follow these steps to enter a password to be used when connecting to your MS750 from a web browser:

1. Press the SETUP push-button on the remote to display the Setup menu. Refer to figure 1.
2. Select the NETWORK menu.
3. Select the MS750 SERVER SETTINGS menu.
4. Enter a password to be used from your PC when connecting from your web browser.

Note: There is no User Name when connecting from a web browser.

MS750 Music Sharing

The MS750 contains a special music sharing feature allowing other Music Servers located on the same network to share their music library into two independent zones. The Music Guide from MS750 or the second Server is merged into the Music Guide of the MS750 to create one seamless Music Guide for browsing and playing all of your music. This effectively can increase the capacity of your MS750 by using additional McIntosh Music Servers.

Note: For more information on connecting together an additional McIntosh Music Server contact your McIntosh Dealer or McIntosh Customer Service.

You can connect together any combination of two MS750 or MS300 Music Servers. Follow these steps to connect your MS750 to another Music Server:

1. Press the SETUP push-button on the remote.
2. Select the Network menu. Refer to figure 4.
3. Select the Remote Server Connection menu.
4. Select one of the available MS750 servers from the server list.
5. Select the Save button to save your selection.

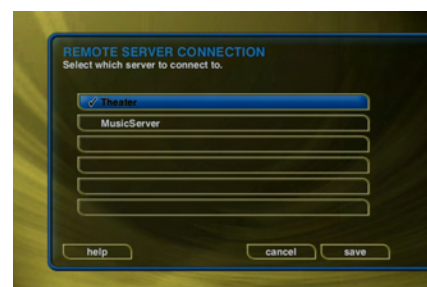

When you return to the Music Guide you will have access to all your music from both Servers merged into one Music Guide. The “Location” field in the Music Guide will show you where each music title is located. Repeat the above steps using the other MS750 to access the first MS750’s music from the second MS750.

Selecting the Audio Encoder Type

You can specify which audio encoder (MP3 or FLAC) you want to use for recording audio in to your MS750. The MP3 format allows the most flexibility and compatibility for efficiently storing many audio files while the FLAC format uses considerably more space than MP3 files, but preserves an exact bit-for-bit recording of the original, using half the space of the original CD. Follow these steps to select an audio encoder:

1. Press the SETUP push-button on the remote to display the Setup menu. Refer to figure 1.
2. Select the Audio menu. Refer to figure 5.
3. Select the Recording Preferences menu.

4. Select MP3 or CD Quality (FLAC) as your preferred encoder.
5. If you selected MP3 as your preferred encoder, select a bitrate.



Figure 5

The MP3 bitrate is used to determine the relative quality and compression level. The higher the bitrate, the better quality and more space each song will occupy on the hard drive. Selecting a lower bitrate will provide lesser quality audio and will use less space for each song, allowing you to store more songs on your MS750.

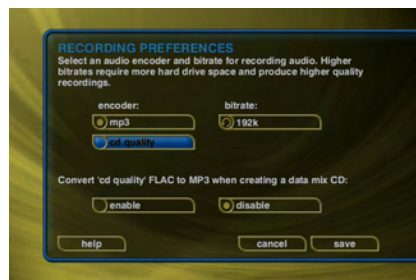

FLAC audio will always take up approximately 50% of the original WAV/AIFF file size. The FLAC compression level has been optimized to the MS750's processor speed and is not user adjustable. Creating a mix CD from FLAC audio files creates a CD which is identical to the original, thus it is referred to as "CD Quality".

Setting the Disc Insert Preferences

You can specify what to do with new discs inserted into MS750's front panel CD drive. "Display and Play" will display the information for the disc and then play the disc. Record and Eject assists in bulk recording, allowing you to insert disc after disc, automatically recording then ejecting each one. Follow these steps to set the Disc Insert Preferences:

1. Press the SETUP push-button on the remote to display the Setup menu. Refer to figure 1.
2. Select the Audio menu. Refer to figure 5.
3. Select the Disc Insert Preferences menu.
4. Select Display and Play or Record and Eject.



Record and Eject will use the current Recording Preferences to record each disc to your internal hard drive. The Record Select Guide will not be displayed as all tracks are automatically selected and recorded to the internal hard drive. Use the Delete Music feature to delete any unwanted tracks.

Video Format

Allows you to select 4:3 or 16:9 aspect ratios on your TV screen. Follow these steps to select the MS750 screen:

1. Press the SETUP push-button on the remote to display the Setup menu.
2. Select the Video menu. Refer to figure 6.
3. Select the Video format menu.
4. Using the Up and Down push-buttons on the remote, select your desired aspect ratio.
5. Press the SELECT push-button on the remote to highlight the SAVE button.
6. Press SELECT again to save the current desired format.

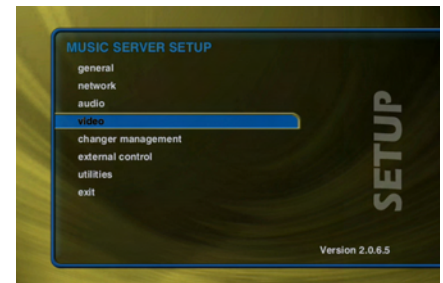

Figure 6



Figure 7



4:3 Aspect Ratio



16:9 Aspect Ratio

Centering the MS750 Screen

Allows you to center the MS750 user interface horizontally on your TV screen. Follow these steps to center the MS750 screen:

1. Press the **SETUP** push-button on the remote to display the Setup menu.
2. Select the **Video** menu. Refer to figure 6.
3. Select the **Screen Centering** menu. Refer to figure 7.
4. Using the **Left** and **Right** push-buttons on the remote, adjust the screen so that it appears horizontally centered on your TV.
5. Press the **SELECT** push-button on the remote to highlight the **SAVE** button.
6. Press **SELECT** again to save the current position.

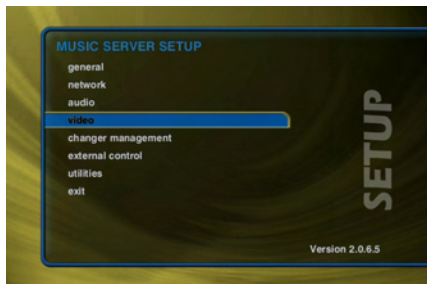

Figure 6

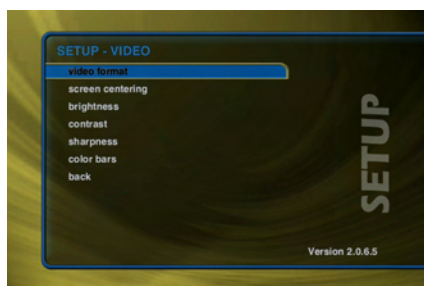

Figure 7



Adjusting your TV's Brightness

Follow these steps to adjust the brightness on your TV:

1. Press the **SETUP** push-button on the remote to display the Setup menu.
2. Select the **Video** menu. Refer to figure 6.
3. Select the **Brightness** menu. Refer to figure 7.
4. Turn your TV's brightness control all the way up then lower it to the point where the vertical black bar on the left just disappears. This will get your brightness control as close to the proper



setting as possible without the use of special software and hardware.

5. Press **SELECT** to return to the previous menu.

Adjusting your TV's Contrast

The Contrast or Picture Adjustment control allows you to optimize the contrast (which is sometimes called Picture) of their TV, using the TV's Contrast or Picture controls. This setting helps reduce video "blooming" and create a clearer, more readable user interface. Follow these steps to adjust the contrast on your TV:

1. Press the **SETUP** push-button on the remote to display the Setup menu.
2. Select the **Video** menu. Refer to figure 6.
3. Select the **Contrast** menu. Refer to figure 7.
4. Turn your TV's Contrast or Picture control all the way up, then lower it to the point where the vertical line appears straight and does not bend. It may not be possible to make it completely straight on some TV sets. This will get your Contrast control as close to the proper setting as possible without the use of special software and hardware.
5. Press **SELECT** to return to the previous menu

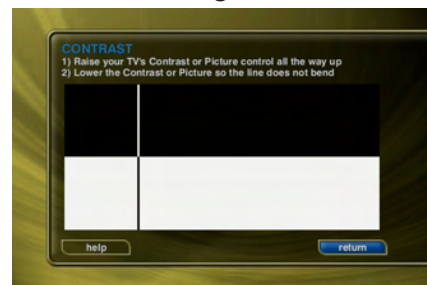

Adjusting your TV's Sharpness

The Sharpness adjustment allows you to set the Sharpness or Detail control of your TV so that onscreen text is as readable as possible. Proper adjustment of the Sharpness control (sometimes called the Detail control) on your TV, allows you to see video and on screen menus more accurately. Follow these steps to adjust the sharpness on your TV:

1. Press the **SETUP** push-button on the remote to display the Setup menu.
2. Select the **Video** menu. Refer to figure 6.
3. Select the **Sharpness** menu. Refer to figure 7.
4. Turn your TV's Sharpness or Detail control up and down until the text on the screen is as read-



able as possible. Be sure to adjust your Brightness and Contrast before adjusting the Sharpness control. This will get your Sharpness control as close to the proper setting as possible without the use of special software and hardware.

5. Press SELECT to return to the previous menu

Adjusting your TV's Color and Tint

Color Bars are used to test the TV monitor's ability to reproduce the proper color values. Follow these steps to adjust the Color and Tint on your TV:

1. Press the SETUP push-button on the remote to display the Setup menu.
2. Select the Video menu. Refer to figure 6.
3. Select the Color Bars menu. Refer to figure 7.
4. Turn your TV's Color and Tint controls up and down until the color bars are at the point where they are not appearing to bleed together and the colors do not appear to be too bright. This will get your Color and Tint controls as close as possible without the use of special software and hardware.



5. Press SELECT to return to the previous menu.

Calibrating the Touch Panel

To obtain the maximum performance from the External Touch Panel, the main user should calibrate the display using the Calibration tool. Follow these steps to calibrate the External Touch Panel:

1. Press the SETUP key on the remote control.

2. Select the External Control Menu. Refer to figure 7.
3. Select the Touch Panel Menu. Refer to figure 8.
4. Select the Calibration Menu. Refer to figure 9.



Figure 8

5. The calibration screen is now displayed.
6. Follow the on screen instructions, by touching the moving target with your finger.

When the calibration procedure is complete, you can operate the MS750 by touching the buttons around the perimeter of the screen. Although these buttons duplicate the functionality of the MS750 remote, you can still use the wireless IR remote even when the External Touch Panel is in use.

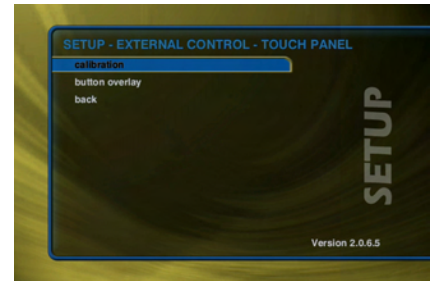

Figure 9



Changing the Touch Panel Button Overlay

The Button Overlay feature places button controls onto the MS750 user interface for use with the External Touch Screen Panel. The External Touch Screen Panel is automatically detected on the MS750 serial ports and the select overlay is enabled. Refer to figures 7, 8 and 9.

You may choose to manually enable or disable the External Touch Panel overlays. There are two types of overlays, the Button Frame and the Toggle Bar. The Button Frame is useful for panels that are capable of displaying video in the overscan area. The Toggle Bar is useful for panels that can not display video in the overscan area. The Toggle Bar should be used for most External Touch Panel Systems.

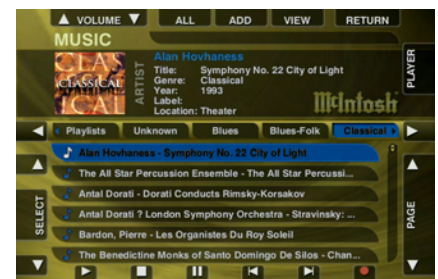
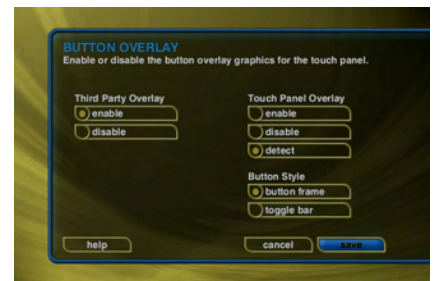

Button Frame Interface



Toggle Bar Interface

Using Your Touch Panel

The Touch Panel Overlay should now be displayed around the edges of your screen. These buttons duplicate the functions found on the remote control and allow you to interact and control the MS750 by touching each button on the External Touch Panel.

IR Remote Control

The MS750 is preset from the factory to operate from the MS1 source button, however, the MS750 can be configured to use any one of the four source buttons using the on screen Setup menus. This is useful when there are multiple MS750s installed at the same location, so all MS750s don't respond to the same IR commands. Use the following steps to change which source button (MS1, MS2, MS3, or MS4) so each MS750 will only respond to commands sent to it.

1. Press the Setup push-button on the remote to display the MS750 setup menu. Refer to figure 6.
2. Select the External Control menu item. Refer to figure 8.
3. Select the IR Remote Control menu item.
4. Select which source button to use to control this MS750.
5. Press the new source button on your remote to recon-

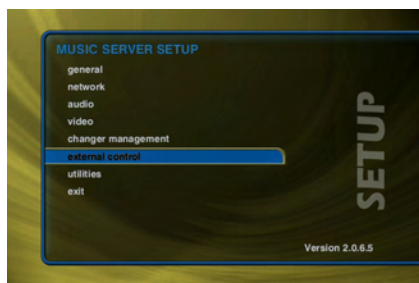

Figure 6



Figure 8

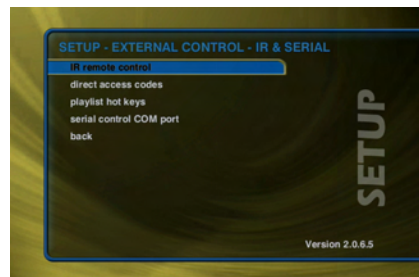

figure the remote and confirm the change by selecting the OK button on screen.

Note:

Repeat these steps for each MS750 in your system, selecting a different MS(1-4) button for each.

Direct Access Codes

Direct Access Codes are used in conjunction with the MACRO push-button on the remote control to provide an IR code sequence to access just about any media in your MS750 server. This is useful for programming third-party external control systems and programmable IR remote controls. The Direct Access Codes are available for all music and movie titles, Play Lists, groups, and radio stations. Follow these steps to view the direct IR codes for your MS750 content:

1. Press the Setup push-button on the remote to display the MS750 setup menu. Refer to figure 6.
2. Select the External Control menu item. Refer to figure 8.
3. Select the Direct Access Codes menu item.
4. Select which codes you want to view:
 - A. Music Titles
 - B. Music Discs
 - C. Music Play Lists
 - D. Music Groups
 - E. Radio Stations

Note: You can make a print out of this information by using the MS750 Web Server Interface. Connect to your MS750's IP address and look under Setup/Direct Access Codes.

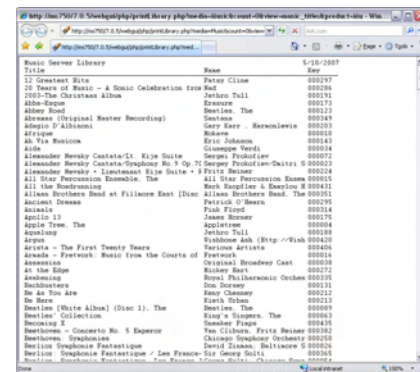
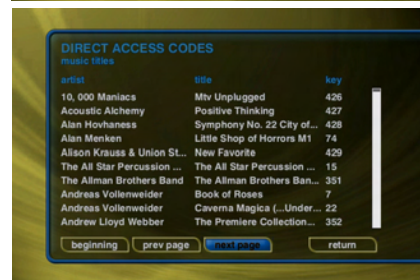
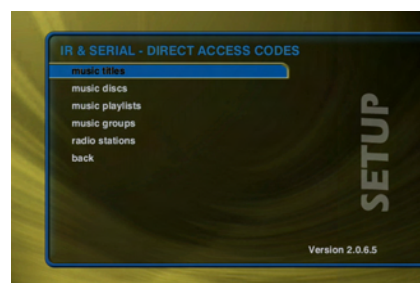

Play List Hot Push-buttons

When the MS750 is controlled by an External Control System creating Play List Hot Push-buttons will provide a

Macro sequence. This will allow direct access to any five Play Lists in your Music Collection using any of these five push-button combinations:

- Control + Backspace
- Control + Insert
- Control + Delete
- Control + Top
- Control + Bottom

Follow these steps to assign a Play List to one of the five available Remote Control Push-button or Touch Panel combinations:

1. Press the Setup push-button on the remote to display the MS750 setup menu. Refer to figure 6.
2. Select the External Control menu item. Refer to figure 8.
3. Select the IR & Serial menu item.
4. Select the Play List Hot Push-buttons menu item.
5. Select one of the five push-button combinations from the spin control using the SELECT button on the remote.
6. Navigate down to the list and select which Play List to assign to the current push-button combination.
7. Repeat steps 4 and 5 for each push-button combination.

Note: If there is nothing in the Play List Hot Push-buttons list, you must first create Play Lists on your MS750.

Serial COM Ports

The Serial Control COM Port setting is used to specify which RS-232 serial COM port is to be used for two-way external control communications with a third party control system. If there are no available COM ports, you must use the Ethernet based external control for two-way external control communications with a third party control system. Follow these steps to select which serial port to use for external control:

1. Press the Setup push-button on the remote to display the MS750 setup menu. Refer to figure 6.
2. Select the External Control menu item. Refer to

figure 8.

3. Select the IR & Serial menu.
4. Select the Serial Control COM Port menu item.
5. Select which serial port to use for external control.

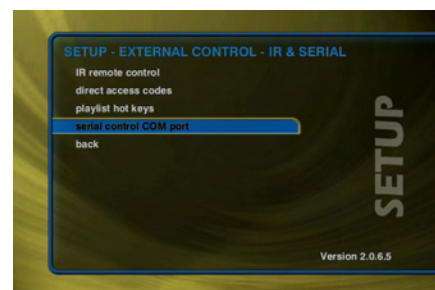

MS750 Utilities

Information about your MS750 hardware and software is available under the Utilities menu. This information is useful for troubleshooting any problems you may encounter with your network connection or verifying the current software versions. Follow these steps to view the MS750 system information:

1. Press the SETUP push-button on the remote to display the Setup menu. Refer to figure 6.
2. Select the Utilities menu.
3. Select the System Information menu.

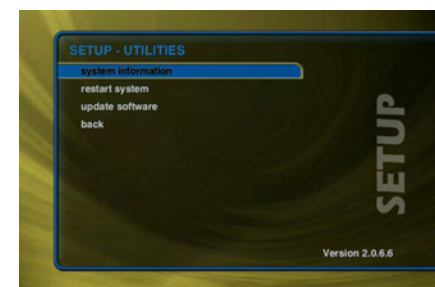

Restarting the System

There are two ways of manually performing a full restart or reboot of the MS750 system, one using the front panel power button and the other using the Restart System menu.

Follow these steps to restart the system using the Front Panel STANDBY/ON Push-button:

1. Press and hold the STANDBY/ON Push-button for 4 seconds.
2. When the STANDBY/ON LED on the front panel begins to flash, release the power button.
3. When the STANDBY/ON LED on the Front Panel, is On (no longer flashing) the MS750 is ready to use.
4. Press the STANDBY/ON Push-button to turn On the MS750.

Follow these steps to restart the system using Utilities menu:

1. Press the SETUP push-button on the remote to display the Setup menu. Refer to figure 6.
2. Select the Utilities menu. Refer to figure 9.
3. Select the Restart System menu.
4. Confirm that you want to restart the system and select the RESTART button.
5. When the STANDBY/ON LED on the Front Panel, is On (no longer flashing) the MS750 is ready to use.
6. Press the STANDBY/ON Push-button to turn On the MS750.

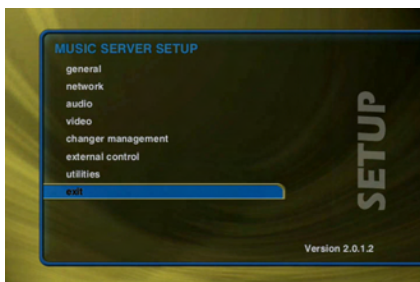

Figure 6

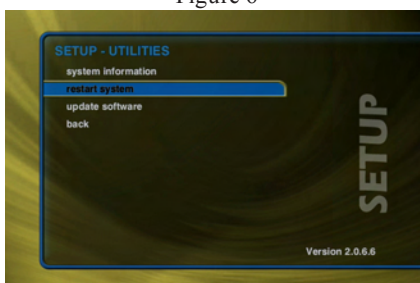
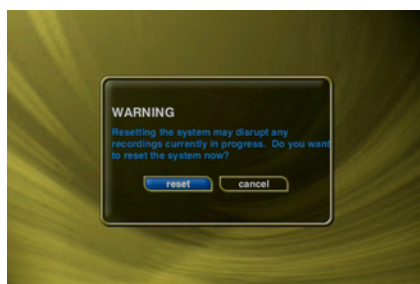

Figure 9



Updating the Software

The MS750 will automatically check the Update Server once a week for any MS750 software updates, and automatically install them. You can also manually check for a software update. Follow these steps to manually update the software:

1. Press the SETUP push-button on the remote to display the Setup menu. Figure 6.
2. Select the Utilities menu. Refer to figure 9.
3. Select the Update Software menu.
4. Select the Check for Update button.
5. Confirm that you want to update the current software.
6. The MS750 will connect to

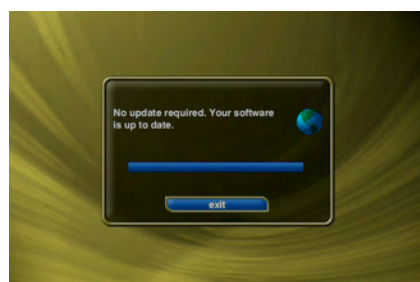

Update Server and compare the current software version with the latest release. If a newer version of the MS750 software is available, it will be downloaded and installed.





How to Operate the MS750

Your McIntosh MS750 has been factory configured for default operating settings that will allow you to immediately enjoy superb audio. If you wish to make changes to the factory default settings, a Setup feature is provided to customize the operating settings using the On-Screen Display (OSD) Menus, refer to page 16 for additional information.

Notes: The MS750 must be connected to a MONITOR/TV either through an A/V Control Center or directly, for setup and use.

The Red LED above the STANDBY/ON switch lights to indicate the MS750 is in Standby mode. To Switch ON the MS750, press the STANDBY/ON Push-button on the Front Panel or press the PWR (Power) Push-button on the Remote Control.

Notes: 1. When AC Power is initially applied to the MS750, the LED located above the STANDBY/ON Push-button

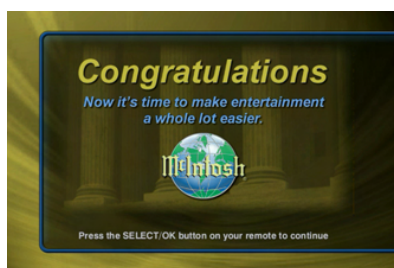

will flash red until the start up process is complete and then go into the Standby Mode. Please wait as this may take several minutes. Refer to the separate folded sheet "MC1A/1B" for additional start up information.

- 2. If power is removed from the MS750 for any reason, including a power outage or if the unit is unplugged, the MS750 will automatically return to the Standby state as soon as power is restored. When it is turned on again, the MS750 will return to the same source mode that it was in when power was lost.*
- 3. If the MS750 becomes unresponsive, PRESS and HOLD the STANDBY/ON Push-button on the Front Panel of the unit for 4 seconds, releasing when the standby LED starts blinking.*

Getting Music Into the MS750

Before you can enjoy the Music features of your MS750 Music Server, you will want to get your music collection into the MS750. The process of getting music into the MS750 is called "Recording" or sometimes "Ripping". There are several ways to get your music into the MS750:

- Record CDs using the internal CD Drive.
- Record CDs using optional external CD/DVD changers.
- Record from an external source (such as a tape, LP, or other real-time source).
- Transfer Music files from your PC using a network.

You may choose to use any or all of these methods at any time. Each is described on the following pages.

Recording from the Internal CD

The easiest way to get music into your MS750 is to record CDs using the built-in internal CD-RW drive. This method requires no additional equipment and is very fast, as the internal CD drive can rip audio at several times the speed of normal playback. This is known as "fast-ripping". Follow these steps to record using the internal CD-RW drive:

1. Press the EJECT push-button on the front panel.
2. Insert an audio CD (label side up) into the CD-RW tray.
3. Press the EJECT push-button again to close the CD-RW tray.



4. The CD's artist, album, and track names are automatically retrieved from the Gracenote® Music Recognition Service and are displayed on your TV.
5. Press the RECORD push-button on the remote control to display the Recording Options Menu.

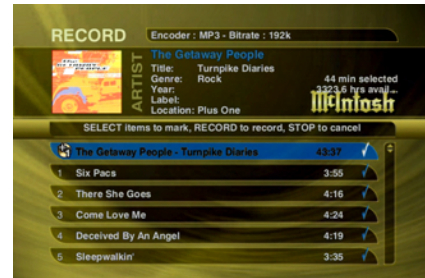

6. Press the RECORD push-button a second time to choose the default recording option "Record to Internal Hard Drive".



7. The Record Select Guide will be displayed showing the current CD with checkmarks to the right of each track name.
8. Press the RECORD push-button a third time to begin recording the entire CD to the internal hard drive.

- When recording is complete, the MS750 will return to the Music Guide.
- Repeat steps 1-8 for each disc in your music collection.
- Highlight and Unselect tracks you do not wish to record before pressing RECORD for the third time.

Note: It is also possible to set the MS750 to automatically copy the CD contents onto the hard drive when the disc is inserted. Refer to page 21 "Setting the Disc Insert Preferences".

Recording From External Changers

In addition to manually loading and recording CDs one by one using the front panel CD drive, you can record as many CDs as you want directly from your external changers.

The advantage of recording multiple discs from your changers is that you don't have to sit there and unload/load each disc after it's recorded; however, there is the disadvantage that external recording must occur in real-time, at 1x record speeds, taking up to several weeks to complete for large music collections.

External Changer recording uses the same recording preferences mentioned above in the "Selecting the Audio Encoder Type" section. Refer to page 21.

Note: Make sure you have both the digital and analog audio connections from your changers connected to the MS750. The MS750 will use the digital inputs first, but if there is digital copy protection on a CD, the MS750 will then attempt to use the analog audio inputs to record the protected CD.

Automatically Recording CDs

You can easily record changer based CDs to your MS750's internal hard drive using the Quick Record feature. Quick Record will record all tracks from newly added CDs which are NOT already recorded to your MS750, in one easy step. Follow these steps to automatically record changer CDs to your MS750:

1. Press the SETUP push-button on the remote to display the Setup menu. Refer to figure 20.
2. Select the Changer Management menu. Refer to figure 21.
3. Select the Record Discs menu.
4. Select the Quick Record menu.
5. The MS750 will determine which changer discs have not been recorded to the internal hard drive, and proceed with recording each disc (all tracks) to the internal hard drive.

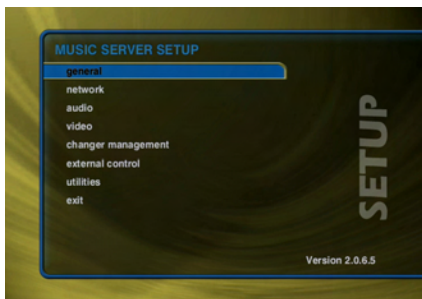

Figure 20

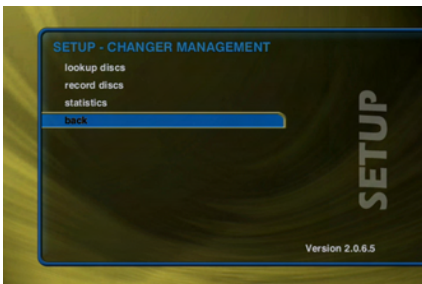

Figure 21

Recording a Range of CDs

If you want to record a specific range of slots in a changer, you can use the Record Range feature. Follow these steps to record a range of changer slots:

1. Press the SETUP push-button on the remote to display the Setup menu. Refer to figure 20
2. Select the Changer Management menu. Refer to figure 21.
3. Select the Record Discs menu. Refer to figure 22.
4. Select the Record Range menu.
5. Enter a valid range of slots to record. If you have more than 1 changer, select which changer you want to use.
6. Select the CONTINUE button.
7. The Record Range screen displays the recording progress for each disc in the selected range. Refer to figure 23.



Figure 22

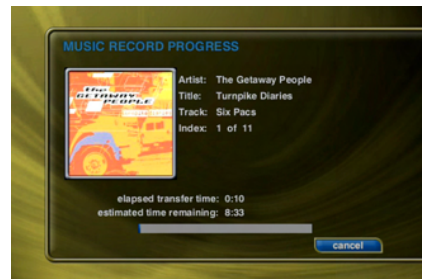

Figure 23



Recording All CDs

If you want to record all discs in all changers, you can use the Record All feature. Follow these steps to record each disc in all changers:

1. Press the SETUP push-button on the remote to display the Setup menu. Refer to figure 20.
 2. Select the Changer Management menu. Refer to figure 21.
 3. Select the Record Discs menu. Refer to figure 22.
 4. Select the Record All menu.
 5. The Record All screen displays the recording progress for each disc in each changer. Refer to figure 23.
- Note: Any tracks already present on the MS750 hard drive will be replaced when recording the same CD again.*

Importing Music Files

If you have digital audio files already recorded on your PC or Mac, you can transfer the files directly to your MS750 using an Ethernet network. This is a fast and convenient way to load up your MS750 with your favorite Music without having to re-record everything.

The MS750 will import each audio file, extract the song information, and add it to your Music Library.

There are some rules to follow to make sure your files are transferred correctly. Please make sure your audio files follow these guidelines before importing them into your MS750.

System Requirements

- 10/100 Ethernet network.
- PC or Mac connected to the same local ethernet network as the MS750.
- Windows XP or Mac OS X.

Audio File Requirements

- MP3 audio files recorded at 96k, 120k, 160k, 192k, 320k, or VBR encoding.
- FLAC audio files.
- AAC audio files (non-DRM) up to 320k.
- WMA files (48-192k CBR and up to 215k VBR).
- WAV files (automatically converted to FLAC or MP3 based on the Recording Preferences).
- ID3 tags are supported for AAC, MP3, and FLAC audio files.

Cover Art Image Requirements

- JPEG image format.
- No larger than 200 pixels wide by 200 pixels high.
- No larger than 30K in size.
- The cover art file must be embedded in the AAC, MP3, or FLAC file using ID3v2 tags.

Importing from a PC

Make sure your PC is connected to the same network as your MS750 and follow these steps to mount, transfer, and import music files from your PC to your MS750.

On the MS750:

1. Press the SETUP push-button on the remote control to display the Setup menu.
Note: This step only needs to be done once.
2. Select the NETWORK menu item.
3. Select the SERVER SETTINGS menu item.
4. Enter a name for your MS750.

On the PC:

1. Go to the START menu and select RUN.
2. Enter two backslashes “\” and the name of your MS750 (the name you entered into the Server Settings) and click the OK button.
3. You should see a new window on your computer.
4. Drag and drop your audio files onto the Import folder. The MS750 will automatically import, add, and catalog each file into your Music Guide.

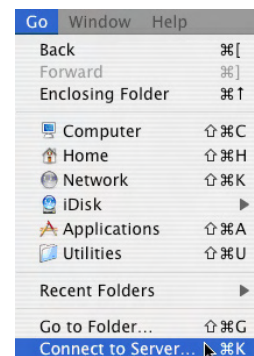
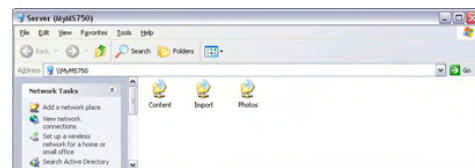
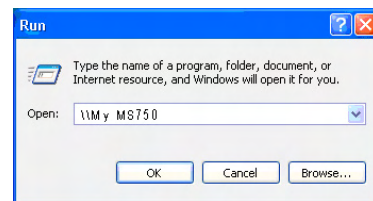

Importing from a Mac

The MS750's File Server acts like a Windows File Server on your network, therefore you will need to connect using the MacOS X's built-in Windows networking client. Make sure your Mac is connected to the same network as your MS750. Follow these steps to mount, transfer, and import music files from your Mac to your MS750.

1. Go to the Finder and select “Connect to Server...” from the Go Menu.
2. Type “smb://750” and the name of your MS750 (the name you entered into the Server Settings) and click the Connect button.
3. You should see the SMB Mount dialog appear on your computer.

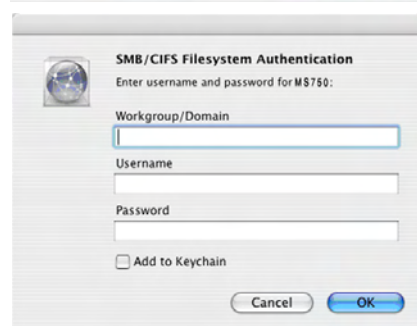
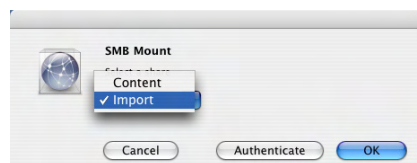
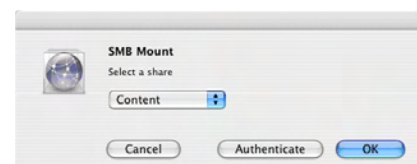
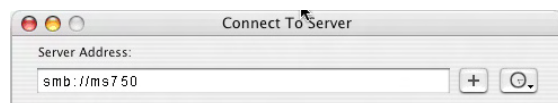

4. Click on the Content pop-up menu and select the Import directory.
5. Next, an authentication dialog will appear. You can ignore this dialog and just click the OK button.
6. You will then have a new drive mounted on your desktop called "Import".
7. Drag and drop your audio files onto the Import folder. The MS750 will automatically import, add, and catalog each file into your Music Guide.

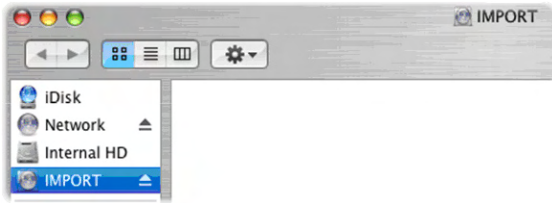

Recording from Other External Sources

In addition to recording from external changers, the MS750 allows you to record directly from its analog inputs to the internal hard drive. Follow these steps to record from an external source:

1. Press the RECORD push-button on the remote control to display the Recording Options Menu. Refer to figure 24.
2. Highlight and select the recording option "Record from Ext Inputs to the Internal Hard Drive".
3. External Record Options screen will be displayed showing the default information for the recording you are about to make. You can use these default settings or edit them. The default recording length is 30 minutes. Enter a different number to increase or decrease the recording time.
4. When you are finished editing the default settings, press the RECORD push-button again to start recording from the external analog inputs to the hard drive.

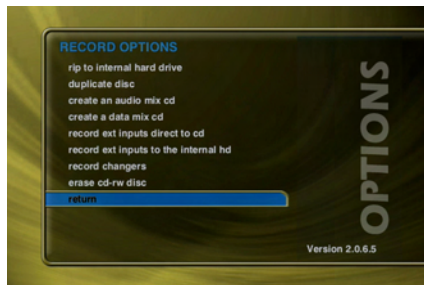
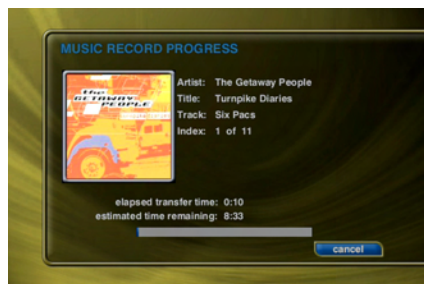

Figure 24



- When recording is complete, the MS750 will return to the Music Guide.

- Recording from the External Inputs creates one Title with one Track and adds the Title to the Music Guide.
- You can edit the data later, just like any other Title. Please refer to the "Managing Your Media" section for more details.

Erasing a CD-RW Disc

You can use the MS750's built-in CD burner to erase the contents of a re-writable CD. Follow these steps to erase a re-writable CD.

1. Press the RECORD push-button on the remote to display the Record menu. Refer to figure 24.
2. Select the Erase CD-RW Disc menu.
3. Confirm that you want to proceed with completely erasing the disc by selecting the ERASE button on screen.

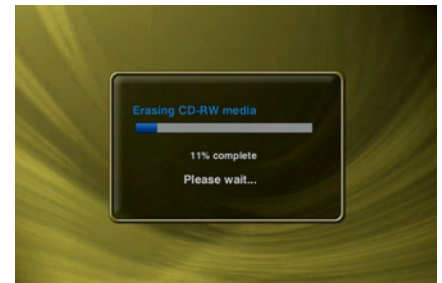

- You will not be able to interrupt the erase function.
- When the MS750 completes erase disc function, it will be ejected. Remove the now blank CD-RW disc and close the CD tray.

Browsing your Music Library

Now that you have gotten your music into your MS750, it's time to enjoy it!

The Music Guide allows you to browse, locate, and play all of your music in one easy to use on-screen guide. Press the MUSIC push-button on the remote control to access your music collection.

The Music Guide displays a scrolling list of all your Music Titles. Using the remote control, you can navigate up and

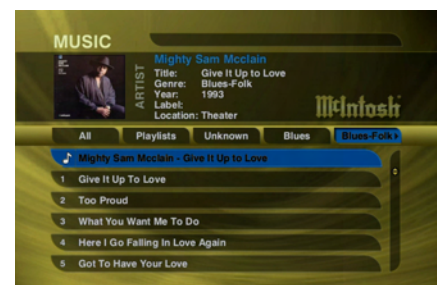
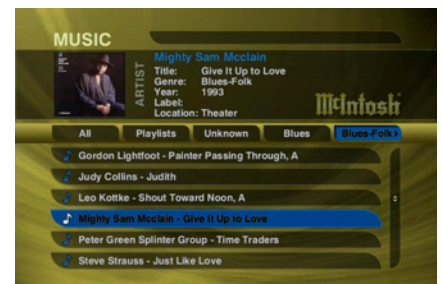

down the list. As each Title is highlighted, you will notice that the Information Area and Cover Art changes to reflect the currently highlighted Title.

Show and Hide Tracks

If you press the SELECT push-button on the remote control, you will expand the current Title to reveal a list of the Title's TRACKS. Press the SELECT push-button again (when a Title is highlighted) to collapse the current Title and hide the track names.

Playing the Current Title

Playing the currently highlighted Title is the same as playing a CD in a conventional CD player. Simply press the PLAY push-button on the remote control and it begins to play from track 1.

Note: If you press SELECT with a Track highlighted, you will start playback from the selected Track.



You'll notice that a new screen appears with a list of the songs (or tracks) on the current Title, this is the Music Player screen. The Music Player displays the artist name, album name, album cover art, and track list for the current Title.

Selecting a Different Song

In the Music Player you can navigate up and down the track list using the remote control. Highlight a different song and press SELECT to play the song.

Playing the Current Title

Playing the currently highlighted Title is the same as playing a CD in a conventional CD player. Simply press the PLAY push-button on the remote control and it begins to play from track 1.

Note: If you press SELECT with a Track highlighted, you will start playback from the selected Track.

You'll notice that a new screen appears with a list of the songs (or tracks) on the current Title, this is the Music Player screen. The Music Player displays the artist name, album name, album cover art, and track list for the current Title.

Changing the Guide View

The GUIDE button on the remote control is used to switch between the Music Guide and Music Player screens. When you are viewing the Music Player screen, press the GUIDE button to return to the Music Guide.

The Music Guide provides you with several ways to view the contents of your Music Library. One of the easiest ways to browse and sort your Music Library is by using the Music "Views". There are six Views that you can switch between using the "MENU/VIEW" push-button on the remote control:

- Artist
- Artist - Title
- Title - Artist
- Song
- List
- Cover

View By Artist

View By Artist is the default View and displays your Music Library alphabetically from A to Z using according to the Artist Name. Expanding the Artist Name displays the albums by that artist. Further expanding the albums, displays the songs within each album.

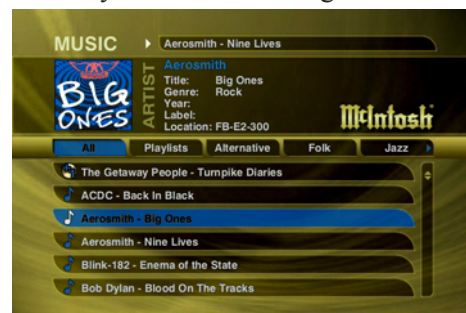

View By Artist-Title

View By Artist-Title displays your Music Library alphabetically from A to Z using according to the Artist Name then the Album Name.

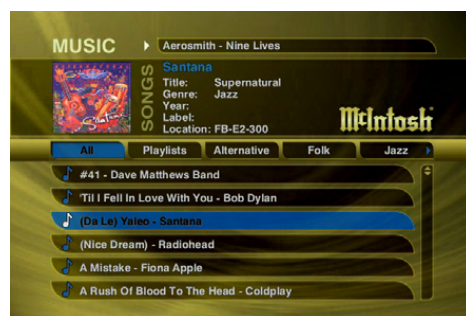

View By Title-Artist

View By Title will order the list of Titles alphabetically from A to Z, according to the Album Name then the Artist Name.

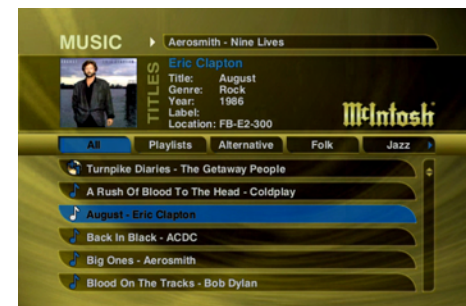

View By Song-Artist

View By Song will order the list of Titles alphabetically from A to Z, according to the Song Name.

View By List

View By List displays a nine line hierarchical view of your music library starting by Genre, then by Artist, Album, and finally by songs.

View By Cover

View By Cover displays a graphical grid of album cover art, sorted alphabetically from A to Z, according to the Artist Name then Album Name.



Using the Guide Views

You can select which Music Guide Views to cycle through when pressing the VIEW button on the remote. This allows you to use all of the views or just the ones that you find most useful for browsing your music library.

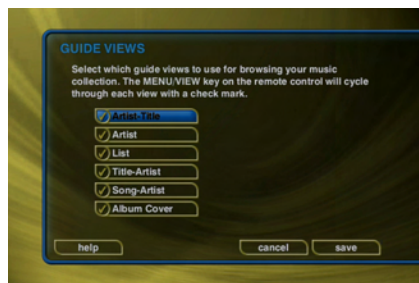

Select Music Options, then Guide Views to display the Guide Views options screen. Highlight then select/unselect each view that you want to include in the cycle.

Changing the Current Play Mode

The default Play Mode will play the current Title from Track 1 to the last track in order, then stop. If you want to change the order of how tracks are played, there are six different Play Modes to choose from:

- Normal - play each track in order in the current Title, then stop.
- Repeat Track - repeat the same track over and over until you press stop.
- Repeat Title - play each track in the current Title in order then repeat the

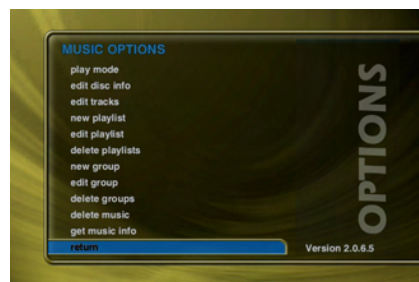

entire disc until you press stop.

- Repeat Group - play each track in each title in the current group and then repeat them until you press stop.
- Random Title - randomly select and play a track from within the current title. Continue until you press stop or every track in the current title is played.
- Random Group - randomly select and play a track from any title in the current group. Continue until you press stop or every track in the current group is played.

To change the current Play Mode, press the MODE push-button on the remote control. Each press of the MODE push-button will switch to the next Play Mode. Stop pressing the MODE push-button when you see the desired Play Mode appear on the screen. You can also directly select a Play Mode using the OPTIONS push-button and the Play Mode menu item.



Jukebox Play Modes

If Jukebox mode is enabled, the available Play Modes will be:

- Normal - play the jukebox queue in order, then stop.
- Repeat - play the jukebox queue in order, over and over without stopping.
- Random - randomly select and play a track from the jukebox queue until you press stop or every track in the queue has been played.

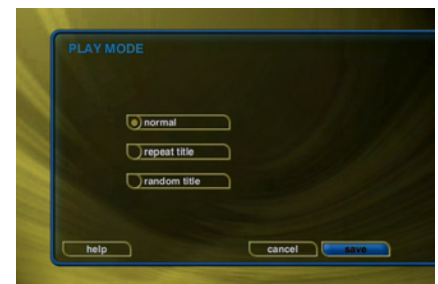

Viewing By Genre

In addition to the current Guide View, the Music Guide automatically organizes your Music into default “Genres” also called “Groups”. The Group Bar displays a horizontal scrolling list of Genres corresponding to the music in your library. Five Genres or Groups are visible at one time. The “All” genre is the default, which displays all Titles in your Music Library.

Using the LEFT and RIGHT arrow push-buttons on the remote, you can select a different Genre. Notice that

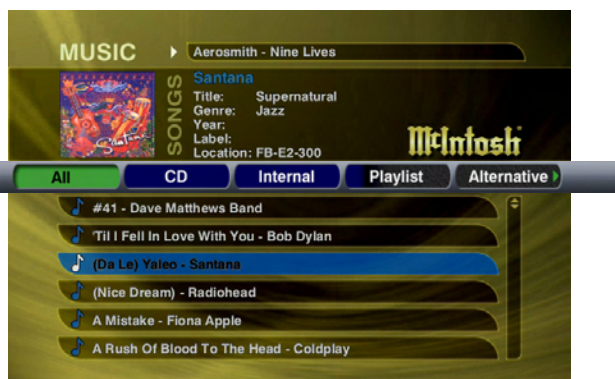

the list of Titles updates to show only Titles in the selected Genre.

- Scroll all the way to the left to return to the All Genre.
- Genre list will scroll to the right to reveal more Genres.

Using the Jukebox Mode

By default, the MS750 plays music from a “Play List” or “disc” based song list, meaning that you select an Artist-Title, Title, or Cover and it plays the entire Album you selected (according to the current Play Mode). If you select something else, what is currently playing is stopped and the newly selected music starts to play.

Alternatively, the Jukebox Mode allows you to create a list of songs (or a song queue if you will) to play while you are listening to something else, similar to the way you would use a traditional coin operated jukebox.

Adding Songs and Playing the Jukebox Queue

Follow these steps to select and play music using the Jukebox Mode:

1. Press the MUSIC push-button on the remote to make sure you are in the Music Source Mode.

2. Locate and highlight any Genre, Artist, Album, or Song in the Music Guide that you want to play in Jukebox mode.

3. Press the ADD FAVORITES Push-button on the remote control to add the highlighted item to your Jukebox Queue.

4. Press the PLAY Jukebox (FAVORITES) Push-but-

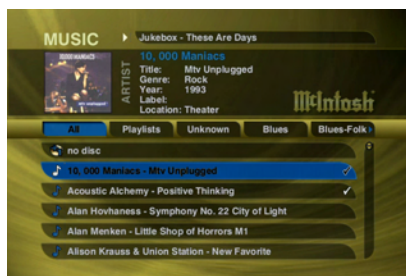

ton on the remote control to display the Music Player screen and play your Jukebox Queue.

5. If you want to add more music to your Jukebox Queue, press the GUIDE push-button on the remote to return to the Music Guide and use the ADD Jukebox (FAVORITES) Push-button to add more music. You will notice that music you Add doesn't play right away as it is added to the end of the Jukebox Queue.

Note: Use the ADD FAVORITES and PLAY FAVORITES push-buttons on the remote control instead of Jukebox push-buttons. Use these push-buttons to add and play your Jukebox Queue.

The Jukebox Queue has a limit of 1000 songs (which would play non-stop for almost 3 days straight!) so the MS750 will automatically balance and adjust the contents of the queue as you select items into it. For example, if your Jukebox Queue already has 1000 items, you can still use the ADD Jukebox (FAVORITES) push-button to add another artist (which may contain several albums and dozens of songs) to the queue. The MS750 will add tracks from the selected artist into the queue while automatically removing other tracks to make room for the new ones.

Reordering the Jukebox Queue

Follow these steps to reorder tracks in the Jukebox Queue:

1. Make sure you are viewing the Music Player screen or press the GUIDE button to hide the Guide and display the Player screen.
2. Highlight the track you want to move.
3. Press the LEFT arrow push-button on the remote to move the highlighted track up in the Jukebox Queue or press the RIGHT arrow push-button to move it down.

Removing a Song from the Jukebox Queue

Follow these steps to remove one song at a time in the Jukebox Queue:

1. Make sure you are viewing the Music Player screen or press the GUIDE button to hide the Guide and display the Player screen.
2. Highlight the track you want to remove.
3. Press the TOGGLE push-button (the one with the double spinning arrows on it) to remove the highlighted track from the Jukebox Queue.

Clearing the Entire Jukebox Queue

Follow these steps to remove all songs from the Jukebox Queue:

1. Press the MUSIC push-button on the remote to make sure you are in the Music Source Mode.
2. Select the Jukebox Menu Item.

3. Select the Clear Queue button. All songs are cleared from the Jukebox Queue.

Saving the Jukebox Queue

Follow these steps to save the Jukebox Queue as a Play List:

1. Press the MUSIC push-button on the remote to make sure you are in the Music Source Mode.
2. Press the OPTIONS push-button to display the Music Options Menu.
3. Select the Jukebox Menu Item.
4. Select the Save as Play List button.
5. Follow the same steps for Creating a Play List.

A new Play List is created on your MS750 and your Jukebox Queue is left intact. This is a way to periodically save the Jukebox Queue for later listening.

Exiting Jukebox Mode

Follow these steps to exit the Jukebox Mode and return to play mode.

1. Press the OPTIONS push-button to display the Music Options Menu.
2. Select the Jukebox Menu Item.
3. Highlight and uncheck the Jukebox Mode checkbox.
4. Select the SAVE button to save your selection. The MS750 will now play in title/album mode once again.

Note: You can also exit Jukebox Mode, by highlighting anything in the Music Guide and pressing the PLAY push-button on the remote (instead of PLAY JUKEBOX).

Creating Play Lists

MS750 allows you to organize your favorite songs into custom “Play Lists”. A Play List is simply a group of songs that you choose from your Music Library. Common uses for Play Lists are:

- Collections of your favorite songs.
- Songs that have a similar tempo or feel (mellow mix).
- Custom albums from one or more of your favorite artists.
- Party mixes.
- Workout mixes.

Follow these steps to create your own custom Play List:

1. Press the MUSIC push-button to make sure you are in the Music source mode.
2. Press the OPTIONS push-button to display the Music Options Menu.
3. Select the Play List/New Play List menu item.
4. Using the remote control or push-buttonboard, enter a name for your Play List.
5. Select the CONTINUE button on screen to advance to

the Edit Play List Select Guide.

The Edit Play List Select Guide works just like the Music Guide. Navigate up and down to highlight, expand, or collapse music titles.

6. For each song you want to add to the Play List, highlight the song name and press the SELECT push-button on the remote. A checkmark appears to the right of each selected song indicating that it will be added to the Play List. Press SELECT again to remove the checkmark.

7. When you have selected all of the songs you want to include in the Play List, press the RECORD button on the remote control to save the Play List.

- When you are finished creating your Play List, the Music Guide is displayed highlighting the newly created Play List.
- You can play any Play List the same way you play a music title or CD. Just press the PLAY push-button on the remote control.
- Notice that a Play List genre is added to the Group Bar. The Play List genre will always be available as long as you have at least one Play List in your Music Library.
- “This Play List” in the Group Bar displays which songs are in the current Play List.
- To Reorder Tracks in “This Play List” use the REW and FF push-buttons to move the highlighted song up or down in the Play List.

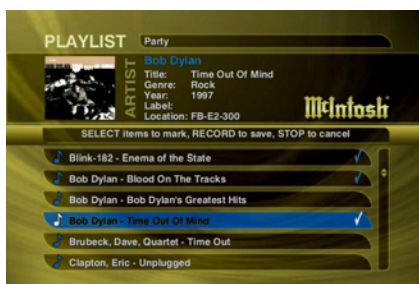
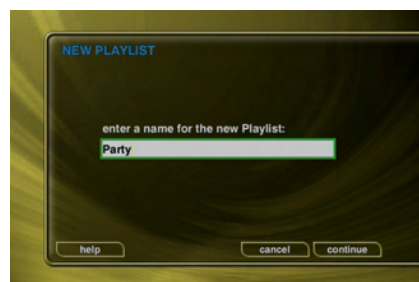
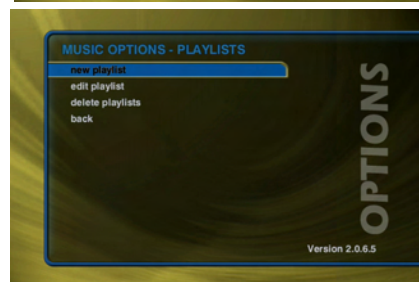
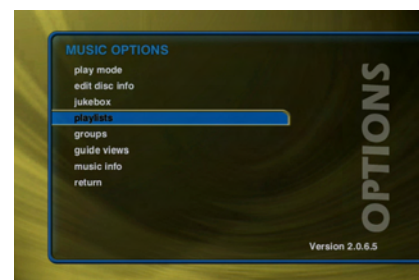

Creating Groups

In addition to Play Lists, the MS750 allows you to create custom “Groups” of Music Titles or Radio Stations. User created Groups appear in the Group Bar along with the automatically created Genre Groups and System Groups (All, CDs, Internal, and Play Lists). Some uses for custom Group are:

- Organize music titles or radio stations into custom genres, like “Funk”, 80’s, “Hits”, etc...
- Group all of the albums for favorite artists together for quick access.
- Create an easily accessible collection of your favorite albums.

To create a custom Group, follow these steps:

1. Press the MUSIC push-button to make sure you are in the Music source mode or press the RADIO push-button if you want to create a custom Radio Group.
2. Press the OPTIONS push-button to display the Options Menu.
3. Select the GROUPS/New Group menu item.
4. Using the Remote Control or Touch Panel, enter a name for your Group.
5. Select the CONTINUE button on screen to advance to the Edit Group Select Guide. The Edit Group Select Guide works just like the Music or Radio Guide.
6. For each Movie, Music Title, or Radio Station you want to add to the Group, highlight the Title or Station name and press the SELECT push-

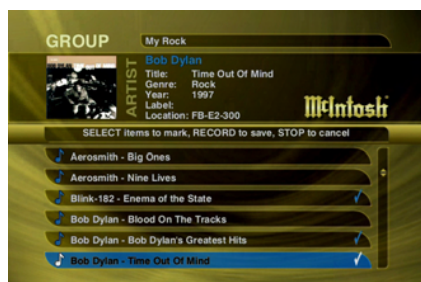
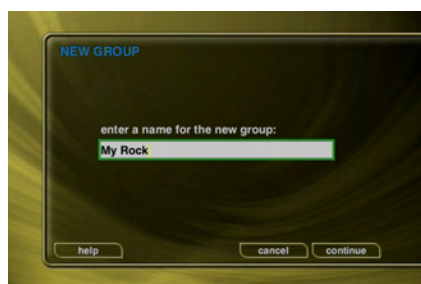
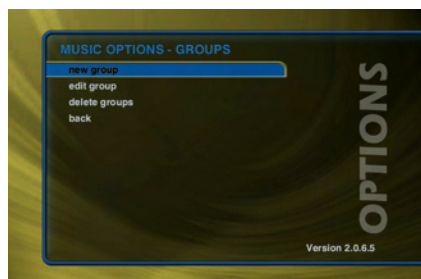
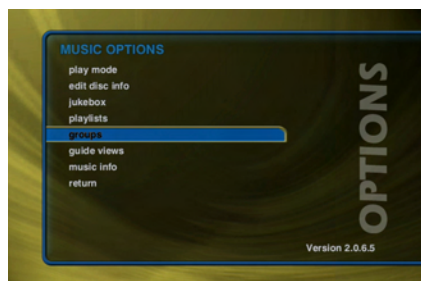

button on the remote. A checkmark appears to the right of each selected Title or Station indicating that it will be added to the Group. Press SELECT again to remove the checkmark.

7. When you have selected all of the Titles or Stations you want to include in the group, press the RECORD button on the remote control to save the Group.

- When you are finished creating your Group, the Guide is displayed highlighting the newly created Group.
- Notice that a custom Group is added to the Group Bar along with the System Groups.
- The custom Group will always be sorted alphabetically within the Group Bar and appear to the right of the All and Play List Groups.

Browsing Internet Radio Stations

The Radio Guide displays a scrolling list of Internet Radio Stations. Using the remote control, you can navigate up and down the list. As each Station is highlighted, you will notice that the Information Area and Cover Art changes to reflect the currently highlighted Station.

- Press the iRADIO push-button on the remote control to display the Radio Guide.
- Press the MUSIC push-button to return to the Music Guide.

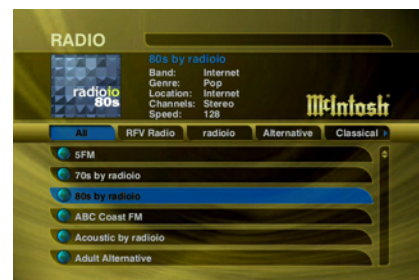

Playing the Current Station

Playing the currently highlighted Radio Station is the same as selecting and playing an off air radio station on a typical audio receiver. Simply press the SELECT push-button on the remote control and the currently highlighted station will be located, buffered, and then played.

You’ll notice that a new screen appears displaying information about the selected station. This is the Radio Player screen. The Radio Player displays the station name, location, genre, genre cover art, and status about the current Internet Radio station stream.

- Playing Internet Radio requires a valid Internet connection.



- Although some stations will work over a Dialup Internet Connection, a broadband Internet connection is recommended.
- Due to the dynamic nature of the Internet, you may experience periodic audio drop-outs which could be due to many factors such as Internet access problems, busy networks, etc...
- Internet Radio Stations are not hosted by McIntosh and may not be available at all times. You can update your Internet Radio Stations list by running Tune Stations.
- Cover art, song name, and artist name are displayed only if the information is sent by the Internet Radio Station broadcaster.

Adding Internet Radio Stations

The MS750 comes preloaded with several high quality streaming Internet Radio Stations from around the world, but that may not be enough for you, so the MS750 also allows you to add your own Internet Radio Stations. Internet Radio stations must conform to these specifications:

- Windows Media WMA or MPEG II layer 3 streams.
- Windows Media 9 or earlier.

To add your own Internet Radio Stations, you will need to obtain the URL or Internet Link to the stream using your PC. Assuming you have a valid URL for a station, follow these steps to add your own Internet Radio Station to the Radio Guide:

1. Make sure you are in the Radio source mode by pressing the RADIO push-button on the remote.
2. Press the OPTIONS push-button to display the Options Menu. Refer to figure 25.
3. Select the New Station menu item.
4. Using the remote or push-buttonboard, enter information for the new station including: station name, location, URL, the bit rate of the stream, the genre, the stream type (MP3 or WMA), and the number of channels (mono or stereo).

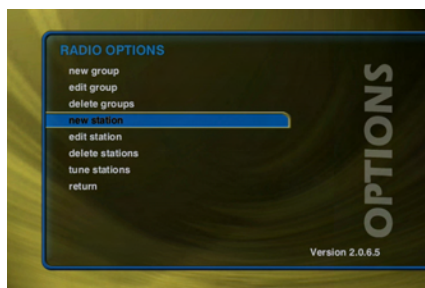
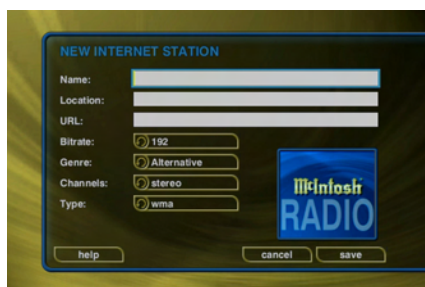

Figure 25



The default cover art will be set according to which genre you select.

5. Select the SAVE button to save the new station.

- When you are finished creating your new station, the Radio Guide is displayed highlighting the newly created Station.
- You can play the station just like any other Internet Radio station.

Updating the Internet Radio Stations List

McIntosh makes every attempt to insure that the preloaded Internet Radio Stations are alive and well, but due to the dynamic nature of the Internet and the third parties who actually serve up these radio streams, sometimes you will not be able to play a station. The “Tune Stations” feature allows you to download a list of the most recent Internet Radio stations from McIntosh.

Note: Tune Stations WILL NOT erase any custom stations you may have added, from your Radio Guide. It WILL replace the McIntosh supplied stations with a fresh new list.

If you want to replace the current Internet Radio Stations with a new list of stations, follow these steps:

1. Make sure you are in the Radio source mode by pressing the RADIO push-button on the remote.
2. Press the OPTIONS push-button to display the Options Menu. Refer to figure 25.
3. Select the Tune Stations menu item.
4. Read the WARNING screen and select OK to proceed.
5. The MS750 will Connect to the McIntosh server and download the latest Internet Radio Stations.



When you are finished Tuning the Stations, the Radio Guide is displayed showing the new McIntosh provided Internet Radio Stations and any user added stations.

Editing Music Information

The MS750 has access to over 4 million CD titles, but you may still encounter a CD that does not return a custom cover or the correct disc information. You can edit the disc information for any Music Title using the Edit Disc and Edit Tracks screens.

Editing Disc Info

Follow these steps to edit the disc information for the current Music Title:

1. Highlight the Music Title you want to edit in the Music Guide.
2. Press the OPTIONS push-button on the remote control.
3. Select the EDIT DISC INFO menu item to display the Edit Disc Information screen. Refer to figure 26.
4. Using the Remote Control or Touch Panel, change the artist name, album title, label, year of release, or genre.
5. Select the SAVE button to save your changes and return to the previous screen.

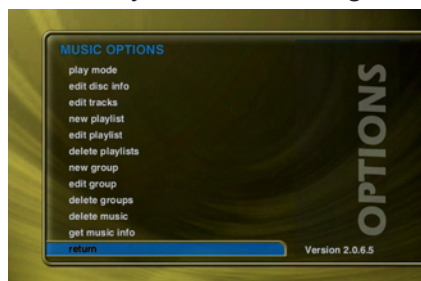

Figure 26

Selecting the Previous or Next buttons will save any edits you have made to the current disc and display the information for the previous or next disc.

Editing Track Names

You can also manually edit the Track/Song names of the currently highlighted Title in the Music Guide. Follow these steps to edit the track information for the current Music Title:

1. Highlight the Music Title you want to edit in the Music Guide.
2. Press the OPTIONS push-button on the remote control.
3. Select the EDIT DISC INFO menu item to display the Edit Disc Information screen.
4. Select the EDIT TRACKS button to display the Edit Tracks screen.

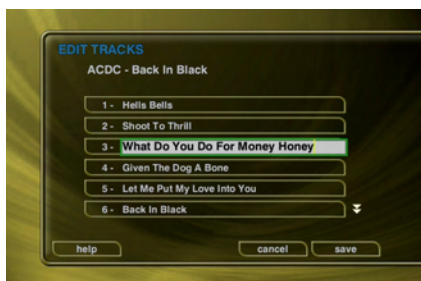

5. Using the remote control or wireless touch panel, change the name of each track.
6. Press the SELECT button to advance to the next track.
7. Select the SAVE button to save your changes and return to the previous screen.

Automatically Lookup Information for This Disc

The “Lookup This Disc” button will initiate a disc lookup for only this disc. The MS750 will connect to the Gracenote® Music Recognition Service to locate and download the disc information. Follow these steps to lookup information for the current disc:

1. Highlight the Music Title you want to edit in the Music Guide.
2. Press the OPTIONS push-button on the remote control.
3. Select the EDIT DISC INFO menu item to display the Edit Disc Information screen. Refer to figure 26.
4. Select the Lookup This Disc button. The Get Music Info screen will be displayed as the MS750 attempts to lookup the disc information from the Gracenote® Music Recognition Service for you. Refer to figure 27.
5. When the lookup is complete, you will return to the Edit Disc Information screen where you can verify or edit the results.
6. Select the SAVE button to save your changes and return to the previous screen.

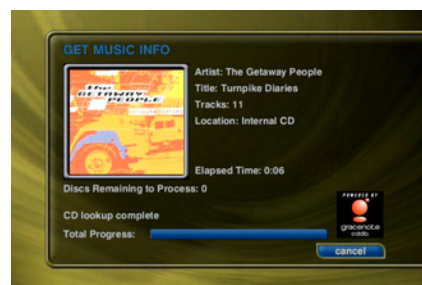

Figure 27

Searching for the Original Cover

Occasionally the wrong cover or the default cover will be displayed for a Music Title. You can manually search for the original cover art by using the “Search for Cover” feature. This is a powerful tool that allows you to search the McIntosh servers for an exact or partial match using the artist name and/or album name. Follow these steps to search for a cover:

1. Highlight the Music Title you want to edit in the Music Guide.
2. Press the OPTIONS push-button on the remote control.
3. Select the EDIT DISC INFO menu item to display the Edit Disc Information screen. Refer to figure 26.
4. Select the Search for Cover button to display the Search for Cover screen.

- The current Artist Name and Album Title are entered as the default search strings. You can change either one of these to modify the search. Note that editing the Artist Name or Title WILL NOT change them in the Music Library. These edits are ONLY used to search for a new cover.
- Select the SEARCH button to start the search.
- The Get Music Info screen will be displayed as the MS750 attempts to search for the cover using the Artist Name and Title you entered. Refer to figure 27.
- When the search is complete, you will return to the Edit Disc Information screen where you can verify or edit the results.
- Select the SAVE button to save your changes and return to the previous screen.

Tips for Searching for Covers

The McIntosh Music Server uses a fuzzy-match algorithm to locate a matching cover using the Artist Name and Title you enter. There are a few tips to try when searching for covers:

- Remove any punctuation marks from the Artist Name and Title.
- Remove Disc Numbers from the Titles.
- Try different spellings in the Title.
- Try removing part of the Artist Name (if it is more than 2 words).

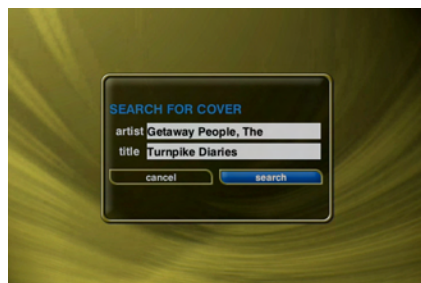

Selecting an Existing Cover

If for some reason you can not download the original cover, you can choose one of the existing covers for the current Title. Follow these steps to select an existing cover to assign to the current Title:

- Highlight the Music Title you want to edit in the Music Guide.
- Press the OPTIONS push-button on the remote control.
- Select the EDIT DISC INFO menu item to display the Edit Disc Information screen. Refer to figure 26.
- Select the Select a Cover button to display the Select Cover Art screen.

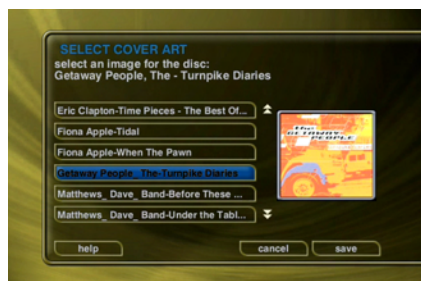

- Using the arrow and page push-buttons on the remote control, locate the name of the Title corresponding to the cover you wish to use for the current Title. Notice that a preview of the selected cover appears on the right of the list as you highlight each name.
- Press the SELECT push-button on the remote control when you have located the cover of your choice.
- Select the SAVE button to save your selection and return to the previous screen.

Editing Radio Information

Similar to editing Music Information, you can also Edit the Radio Information. Follow these steps to edit the station information for the currently highlighted Internet Radio Station:

- Make sure you are in the Radio source mode by pressing the RADIO push-button on the remote.
- Press the OPTIONS push-button to display the Options Menu.
- Select the Edit Station menu item to display the Edit Station screen.
- Using the remote or touch panel, edit the information for the new station including: station name, location, URL, the bit rate of the stream, the genre, type of stream (MP3 or WMA), and the number of channels (mono or stereo). The cover art will be set according to which genre you select.
- Select the SAVE button to save the changes.



Editing Play Lists

You can reorder tracks, change the name, and add or remove tracks from any Play List you created. Follow these steps to edit a Play List:

- Press the MUSIC push-button to make sure you are in the Music source mode.
- Highlight the Play List Name you want to edit.

Note: The Play List group will list all of your Play Lists.
- Press the OPTIONS push-button to display the Music Options Menu.

4. Select the Play Lists/Edit Play List menu item.
5. Using the remote control or touch panel, change the name of your Play List or select the CONTINUE button on screen to keep the current name and advance to the Edit Play List Select Guide.

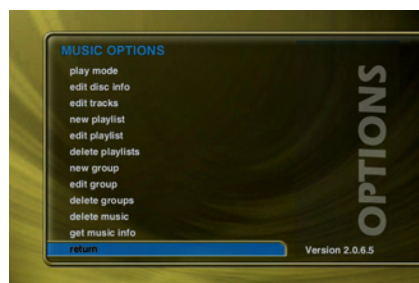
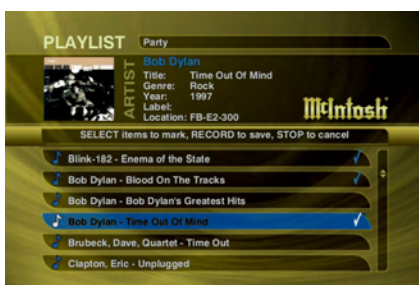
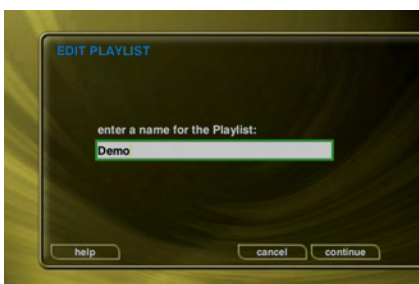
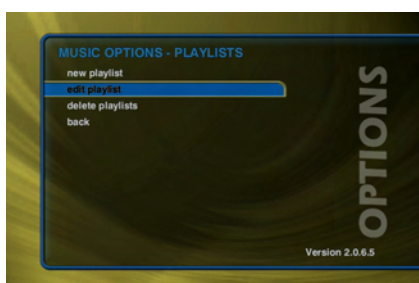

Figure 28

6. For each song you want to add to the Play List, highlight the song name and press the SELECT push-button on the remote. A checkmark appears to the right of each selected song indicating that it will be added to the Play List.
7. For each song you want to remove from the Play List, highlight the song name and press the SELECT push-button on the remote. The checkmark to the right of the song will be removed, indicating that the song should be removed from the Play List.



- If you remove all songs from a Play List, the Play List is automatically deleted.
- There is a 1000 song maximum for Play Lists.
- “This Play List” in the Group Bar displays which songs are in the current Play List.
- To Reorder Tracks in “This Play List” use the REW and FF push-buttons to move the highlighted song up or down in the Play List.

Editing Groups

As with Play Lists, you can also edit the name of a Group, add Music Titles, or Radio Stations to the Group, or remove Music Titles, or Radio Stations from the Group.

Follow these steps to edit a Group:

1. Press the MUSIC push-button if you want to edit the Music Groups or press the RADIO push-button if you want to edit the Radio Groups.
2. Highlight the Group you want to edit within the Group Bar.
3. Press the OPTIONS push-button to display the Options Menu. Refer to figure 28.
4. Select the Groups/Edit Group menu item.
5. Using the remote control or push-buttonboard, change the name of your Group or select the CONTINUE button on screen to keep the current name and advance to the Edit Group Select Guide.

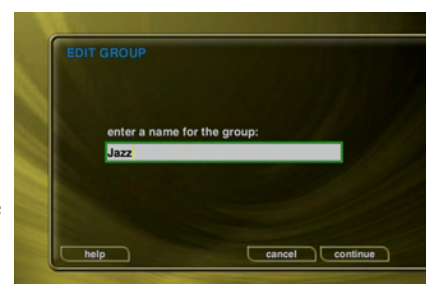
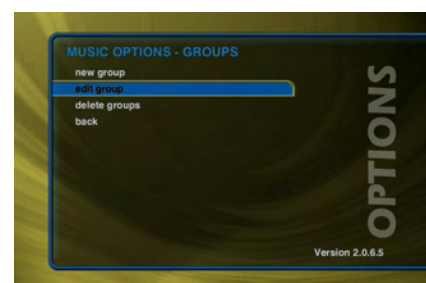

6. For each Music Title or Radio Station you want to add to the Group, highlight the Music Title or Radio Station and press the SELECT push-button on the remote. A checkmark appears to the right of each selected Music Title or Radio Station indicating that it will be added to the Group.
7. For each Music Title or Radio Station you want to remove from the Group, highlight the Music Title or Radio Station and press the SELECT push-button on the remote. The checkmark to the right of the Music Title or Radio Station will be removed, indicating that the Music Title or Radio Station should be removed from the Group.
8. When you have added or removed all of the Music Titles or Radio Stations you want to include in the Play List, press the RECORD button on the remote control to save the Group.

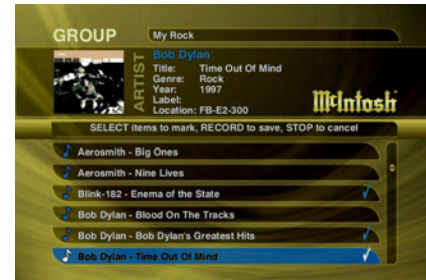

You can not edit the System Groups (All, CDs, Internal, or Play Lists).

- If you remove all Titles or Stations from a Group, the Group is automatically deleted.
- You can not reorder Titles and Stations within a Group. They are always sorted alphabetically.

Deleting Music

You can remove any music you have recorded to the MS750 by using the Delete Music feature. You may want to do this if you have filled up your MS750 and you can not record any more music or if you want to remove songs that you just don't listen to. Follow these steps to delete music from your MS750:

1. Press the MUSIC push-button to make sure you are in the Music source mode.
2. Press the OPTIONS push-button to display the Options Menu. Refer to figure 28.
3. Select the MUSIC INFO/Delete Music menu item to display the Delete Music Info screen.



4. For each Track you want to delete, highlight the Track and press the SELECT push-button on the remote. A checkmark appears to the right of each selected Track indicating that it will be deleted. Press the SELECT push-button again to remove the checkmark. Pressing the Toggle push-button on the remote when a Title is highlighted will toggle all or none of the Title's tracks for deletion.
5. When you have selected all of the Titles you want to delete in the group, press the RECORD button on the remote control to permanently remove and delete the checked tracks.

You can not "delete" physical CDs from the Music Library. You must remove the discs from your changers if you want the CDs to be removed from the Music Guide.

Deleting Play Lists

You may delete entire Play Lists from the Music Guide. Follow these steps to permanently delete one or more Play Lists from the Music Guide:

1. Press the MUSIC push-button to make sure you are in the Music source mode.

2. Press the OPTIONS push-button to display the Options Menu. Refer to figure 28.
3. Select the Play Lists/Delete Play Lists menu item to display the Delete Play Lists screen.
4. For each Play List you want to delete, highlight the Play List and press the SELECT push-button on the remote. A checkmark appears to the right of each selected Play List indicating that it will be deleted. Press the SELECT push-button again to remove the checkmark.
5. When you have selected all of the Play Lists you want to delete, select the DELETE button to permanently remove and delete the checked Play Lists.

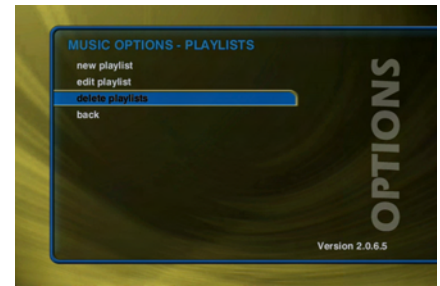

Deleting Groups

Deleting Groups from the Group Bar is very similar to deleting Play Lists. The contents of the Group (the Music Titles or Radio Stations) are not deleted. They are still available in any other Groups they may be assigned to and in the All Group. Follow these steps to delete Groups.

1. Press the MUSIC push-button if you want to edit the Music Groups or press the RADIO push-button if you want to edit the Radio Groups.
2. Press the OPTIONS push-button to display the Options Menu. Refer to figure 28.
3. Select the GROUPS/Delete Groups menu item to display the Delete Groups screen.

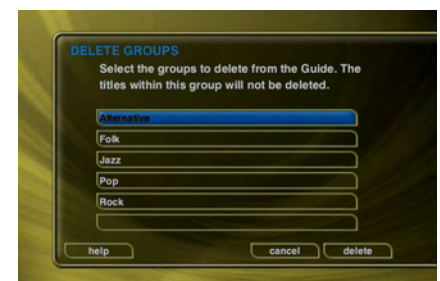
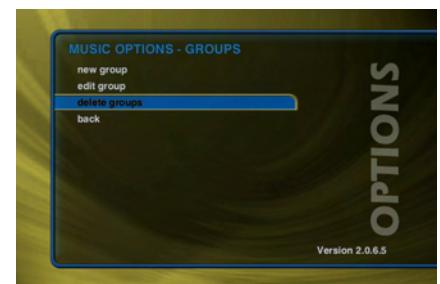

4. For each Group you want to delete, highlight the Group and press the SELECT push-button on the remote. A checkmark appears to the right of each selected Groups indicating that it will be deleted. Press the SELECT push-button again to remove the checkmark.
5. When you have selected all of the Groups you want to delete, select the delete button to permanently remove and delete the checked Groups.
6. You can not delete the System Groups (All, CDs, Internal, or Play Lists).

Creating CDs

The MS750 is a complete media solution for storing, managing, and listening to your music. The MS750 also allows for making a CD of your favorite music to take with you. Create custom mix CDs, backups copies of any physical CD, and record from the external analog inputs to a CD.

Creating a Custom Mix CD

A Custom Mix CD is a collection of songs that you record or “burn” to a blank CD. The new CD can then be played in your car stereo, computer, or any CD player which supports CD-R or CD-RW discs. Follow these steps to create a custom Mix CD:

1. Press the MUSIC push-button to make sure you are in the Music source mode.

2. Press the RECORD push-button to display the Music Record Options menu. Refer to figure 29.



Figure 29

3. Select the Create an Audio Mix CD button if you want to create a standard audio CD which can be played in almost any CD player or select the Create a Data Mix CD button if you want to create a data CD that can be played in any computer or CD player which supports MP3 CDs.

4. When the Music Record Select Guide appears, you can select one or more songs to include on your Mix CD. Navigation of the Record Select Guide is the same as the other Guide screens. Refer to figure 30.

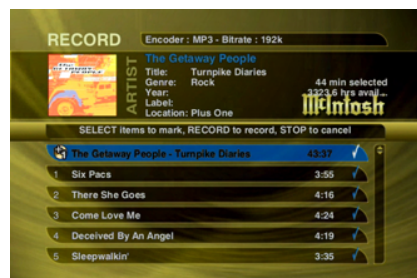

Figure 30

Note: You can select up to 80 minutes or 700 MB of songs because these are the maximum limits of recordable CDs.

5. The “Selected” group shows you which songs you have selected for your CD.
6. To reorder tracks use the REW and FF push-buttons to move the highlighted song up or down in the list.
7. Press the RECORD push-button again to continue the recording process and display the Music Record Progress – CD Read screen. Refer to figure 31.

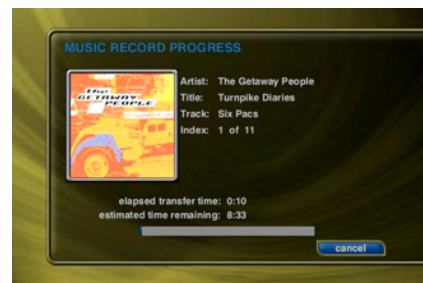

Figure 31

8. The MS750 will read each song you have selected and assemble an “image” of all songs on its internal hard drive.

Note: If you selected any songs which are from changer based CDs, this process may take a while to complete as these songs must be read in real-time.

9. After all of the songs have been read, the MS750 will ask if you want to add any more tracks to the CD. Select Add More if you do want to add more tracks or select Done to continue creating the CD.
10. When the MS750 has added all of your songs and finished creating the new CD image, it will eject the CD tray and ask you to insert a blank CD.
11. Insert a blank CD-R or CD-RW disc and close the CD tray by pressing the Eject button on the front panel.

Note: You must use royalty paid blank CDs which are typically marked as “audio” or “music” CDs when creating an Audio CD. Data CDs typically used for computers can be used for data mix CDs.
12. The Music Record Progress – CD Write screen now appears as the CD image is written to the blank CD.
13. When the CD is complete, the new disc you created will be ejected. Remove the disc and close the CD tray.

Duplicating a CD

You can duplicate any physical disc located in the internal drive or any external changer. These discs are for backup purposes only. Follow these steps to duplicate a CD:

1. Press the MUSIC push-button to make sure you are in the Music source mode.
2. Press the RECORD push-button to display the Music Record Options menu. Refer to figure 29.
3. Select the Duplicate a Disc Button to display the Music Record Select Guide. Refer to figure 30.

4. Select a CD from any external changer or the built-in CD player. A check mark will be placed next to the selected disc.
5. Press the RECORD push-button again to continue the recording process and display the Music Record Progress - CD Read screen. Refer to figure 31.
6. The MS750 will read the selected CD and create an “image” of the CD on its internal hard drive.

Note: If you selected any songs which are from changer based CDs, this process may take a while to complete as the CD must be read in realtime.
7. After the entire CD has been read, the MS750 will eject the CD tray and ask you to insert a blank CD.
8. Insert a blank CD-R or CD-RW disc and close the CD tray by pressing the Eject button on the front panel.

Note: If you are duplicating an audio CD, you must use royalty paid blank CDs which are typically marked as “audio” or “music” CDs. Data CDs typically used in computers can be used for duplicating MP3 CDs.
9. The Music Record Progress - CD Write screen now appears as the CD image is written to the blank CD.
10. When the CD is complete, the new disc you created will be ejected. Remove the disc and close the CD tray.

5. When you are finished editing the default settings, press the RECORD push-button again to start recording from the external analog inputs to the internal hard drive.
6. The MS750 will record from the external analog inputs to a temporary “image” recorded on its internal hard drive.
7. When the recording time elapses and the recording is complete, the MS750 will ask you to insert a blank CD.
8. Insert a blank CD-R or CD-RW disc and close the CD tray by pressing the Eject button on the front panel.
9. The Music Record Progress – CD Write screen now appears as the CD image is written to the blank CD. Refer to figure 31.
10. When the CD is complete, the new disc you created will be ejected. Remove the disc and close the CD tray.

If the MS750 detects that no audio was actually recorded, it will return to the Music Guide without asking you to insert a blank CD. Check your cables and make sure you have audio connected to the analog inputs on the back of your MS750.

Recording From an External Source

The MS750 also allows you to record from the external inputs to a blank CD. This allows you to record live performances or any other analog source to a blank CD which can then be played on almost any standard CD Player. Follow these steps to record direct to CD from an external source:

1. Press the MUSIC push-button to make sure you are in the Music source mode.
2. Press the RECORD push-button to display the Music Record Options menu. Refer to figure 29.
3. Select the Record Ext Inputs Direct to CD menu item.
4. The External Record Options screen will be displayed showing the default information for the recording you are about to make. You can use these default settings or edit them. The default recording length is 30 minutes. Enter a different number to increase or decrease the recording time.

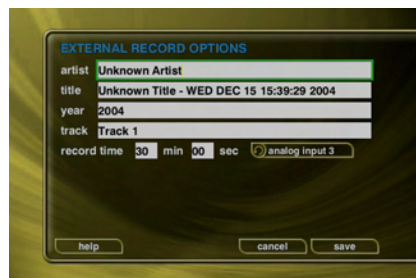

Controlling the MS750 from a Web Browser

The MS750 contains a built-in web server which means you can connect to your MS750 and remotely control it using a standard web browser from a PC, Mac, or PDA over your home network.

Setting up the MS750 Web Server

Your MS750 acts as a web server on your network allowing you to connect and control the MS750 using your PC or Mac computer. This web server is automatically configured and started each time the MS750 is plugged in. Connect to the server from your PC or Mac using Internet Explorer or Safari (Mac OSX) using TCP/IP addressing over your home network. You can use a wireless or wired Ethernet network, as long as you have a DHCP router or if you have assigned static IP addresses. Please contact your McIntosh Dealer if you need assistance with setup of a home network.

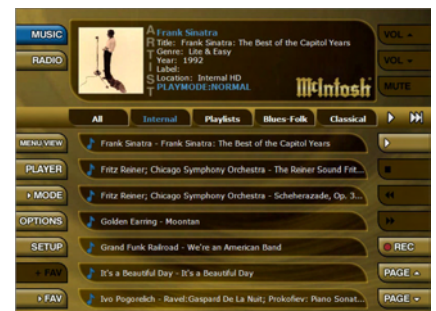



The MS750 Server Name entered on the Server Settings Menu in the SETUP/NETWORK menus is used for the web address to access the MS750 web interface. To access the MS750 web server simply open the web browser on your PC or Mac and enter the MS750 name in the address bar. To access the PDA web interface enter the MS750 name followed by /pda in the address bar. For example, MyMS750/pda.

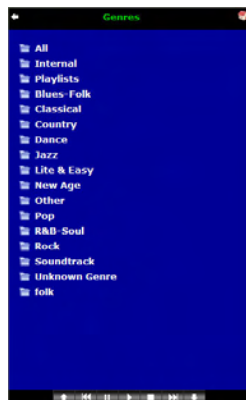

Using the Web User Interface

Using the Web User Interface displayed in your Web Browser, you can control almost every aspect of your MS750. The Web User Interface is setup very similarly to the MS750's own TV user interface allowing access to each source (Music or Radio) as well as all major features such as Setup, Guide/Player, Options and Edit Screens.

Use your touch panel to navigate the web interface instead of the IR remote control. Access to all of the major functions is provided by the buttons along the left and right side of the web interface. These buttons duplicate those found on the remote control.

Using the Web Browser as a Music Client

In addition to remotely controlling your MS750, the built-in web server also functions as a streaming audio server, providing an easy way to add multiple streaming music clients to your MS750.

Note: Your web browser and computer must be setup to properly handle streaming audio files. The proper configuration of these settings is beyond the scope of this document. Please consult with your computer manufacturer or other online support sources for more information about playing audio files on your computer.

Follow these steps to configure the MS750 web interface client mode to either streaming from or remote controlling your MS750:

1. Make sure your web browser is properly configured and connected to your MS750.
2. Click the SETUP button on the left side of the screen to display the Setup Menu.
3. Click the Web Client Mode menu item at the top of the page.



4. Select Streaming Client Mode to set the Web Browser as the streaming music client or select Synchronized Mode to remotely control your MS750.
5. Click the SAVE button to save your selection and exit the Setup Menu.

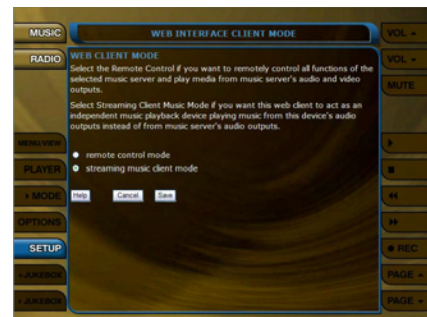

Selecting music from the Web Browser will now cause the music to be played from the computer's own audio system rather than from the MS750 itself.

To set the Web Client Mode back to Remote control, follow these same instructions but select Remote Control Mode instead of Streaming Client Mode.

MS750 Music Backup

It is possible to backup and restore the music contents of a MS750 using the CIFS or "Windows" Networking feature. Backup is accomplished by mounting the MS750 onto your PC or Mac desktop and using your computer's backup software.

You can also backup the music files to any standard media which your PC supports, such as: DVD+/-R, DVD+/-RW, CD-R, CD-RW, or external hard drive.

There are several methods and tools for backing up your MS750's music content. You will have to determine which method is best for you. One such method involves attaching an external FireWire or USB hard drive to your PC and backing up your Content directory by using a simple drag and drop from the Content directory to the external drive or using more elaborate features provided by a third party backup software product such as Dantz Retrospect. A free trial of this software is provided by Dantz for both Mac and Windows users. Please visit the Dantz web site for more details: <http://www.dantz.com/en/products/personal.html>

Only the music files are available in the Content folder. Play Lists are available in the Play Lists folder. Setup information, and Internet Radio stations are NOT available for backup at this time.

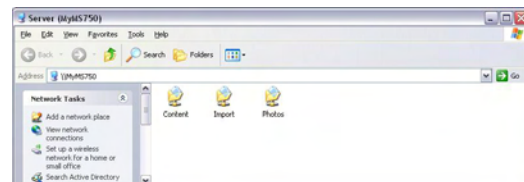

A full 500 GB backup could take 2.5 days to complete using a standard 10/100 baseT Ethernet network. It is not recommended that you use your MS750 to play music while a backup is in progress as this will cause the backup to take longer to complete.

Note: A good place to start is the PC and MAC Integration documents that can be found on the McIntosh Web Site at www.McIntosh.com.

MS750 Music Restore

You can restore music to a MS750 using the same method used for importing audio files into a MS750. Restore and Import both use the CIFS Networking feature to add audio files to a MS750. Simply drag your music files to the Import directory and let the MS750 import the audio files.

Note: This may take several days for a large music collection!

Upon Import, the MS750 will rebuild the internal database based on the music file's ID3 tag information.

ID3 Tag Support

All MP3, AAC, and FLAC files should have the proper ID3 tags in each file in order for MS750 to properly add each music file to its internal Library. The following ID3 tag formats are supported by the MS750:

- ID3v1.0
- ID3v1.1
- ID3v2.2.0
- ID3v2.3.0

Use an ID3 Tag Editor (such as iTunes) to change the ID3 tags to a supported format before importing into the MS750. If your audio files originated from your MS750, they already have the proper ID tags.

Cover art will be imported into the MS750 as long as the cover image is properly embedded into the ID3 tag. Again, use an ID3 Tag Editor on your computer to add cover art images to each audio file prior to importing. Play Lists should also be imported directly to the "Import" directory.

Troubleshooting

Network Problems

If you experience problems registering a MS750 or connecting to the Internet to lookup disc information, try these possible fixes before calling McIntosh Tech Support:

- Make sure that your MS750 is properly connected to your home network and that all cables are in working order.
- The MS750 communicates using TCP/IP and UDP over Ethernet networks using ports 80, 443, and 1755. If you

have a router installed on your network, make sure that these ports are open for TCP and UDP.

- If Dynamic TCP/IP addressing fails, check your router to make sure that it is configured to assign dynamic IP addresses via DHCP and try rebooting your router.
- If DHCP addressing still isn't working, try using static IP addresses. The Internet Assigned Numbers Authority (IANA) has reserved the following three blocks of the IP address space for private networks: 10.0.0.0 - 10.255.255.255, 172.16.0.0 - 172.31.255.255, and 192.168.0.0 - 192.168.255.255. Note that the first block is nothing but a single class A network number, while the second block is a set of 16 contiguous class B network numbers, and the third block is a set of 255 contiguous class C network numbers. The complete RFC 1918 can be found via FTP on <http://nic.ddn.mil>
- Crestron, AMX, or other third party controllers capable of controlling the MS750 over Ethernet use port 251. Make sure your router has port 251 open if you plan on using two-way control over Ethernet.

Software Update Problems

Manual Software Update Checks

Software Updates are automatically checked once a week starting on the day of the week your MS750 was first registered. You can manually check for a software update by accessing the Software Update menu found under the Setup/Utilities Menu.

Recording Problems

Audio vs. Data CDs

The MS750 requires Royalty paid blank media when recording audio CDs. Blank CDs marked with "Data" can not be used when creating Red Book audio CDs. You must purchase and use blank media marked as "Audio" or "Music" CDs.



Gracenote® End-User License Agreement

USE OF THIS PRODUCT IMPLIES ACCEPTANCE OF THE TERMS BELOW.

This product contains technology and data from Gracenote of Emeryville, California (“Gracenote”). The technology from Gracenote (the “Gracenote Embedded Software”) enables this product to do disc identification and obtain music-related information, including name, artist, track, and title information (“Gracenote Data”), which is included on the Gracenote Database (the “Gracenote Database”).

You agree that you will use Gracenote Data, the Gracenote Database, and Embedded Software for your own personal non-commercial use only. You agree that you will access Gracenote Data only by means of the standard end user functions and features of this product. You agree not to assign, copy, transfer or transmit the Embedded Software or any Gracenote Data to any third party. **YOU AGREE NOT TO USE OR EXPLOIT GRACENOTE DATA, THE GRACENOTE DATABASE, OR GRACENOTE COMPONENT, EXCEPT AS EXPRESSLY PERMITTED HEREIN.**

You agree that your non-exclusive license to use the Gracenote Data, the Gracenote Database, and Embedded Software will terminate if you violate these restrictions. If your license terminates, you agree to cease any and all use of the Gracenote Data, the Gracenote Database, and Gracenote Embedded Software. Gracenote reserves all rights in the Gracenote Data, Gracenote Database, and Gracenote Embedded Software, including all ownership rights. You agree that Gracenote may enforce its rights under this

Agreement against you directly in its own name.

The Embedded Software and each item of Gracenote Data are licensed to you “AS IS.” Gracenote makes no representations or warranties, express or implied, regarding the accuracy of any Gracenote Data. Gracenote reserves the right to delete data or to change data categories in any Data updates and for any cause that Gracenote deems sufficient. No warranty is made that the Embedded Software is error-free or that functioning of the Embedded Software will be uninterrupted. Gracenote is not obligated to provide you with any new enhanced or additional data types or categories that Gracenote may choose to provide in the future.

GRACENOTE DISCLAIMS ALL WARRANTIES EXPRESS OR IMPLIED, INCLUDING, BUT NOT LIMITED TO, IMPLIED WARRANTIES OF MERCHANTABILITY, FITNESS FOR A PARTICULAR PURPOSE, TITLE, AND NON-INFRINGEMENT. GRACENOTE DOES NOT WARRANT THE RESULTS THAT WILL BE OBTAINED BY YOUR USE OF THE GRACENOTE COMPONENT OR ANY GRACENOTE SERVER. IN NO CASE WILL GRACENOTE BE LIABLE FOR ANY CONSEQUENTIAL OR INCIDENTAL DAMAGES OR FOR ANY LOST PROFITS OR LOST REVENUES.



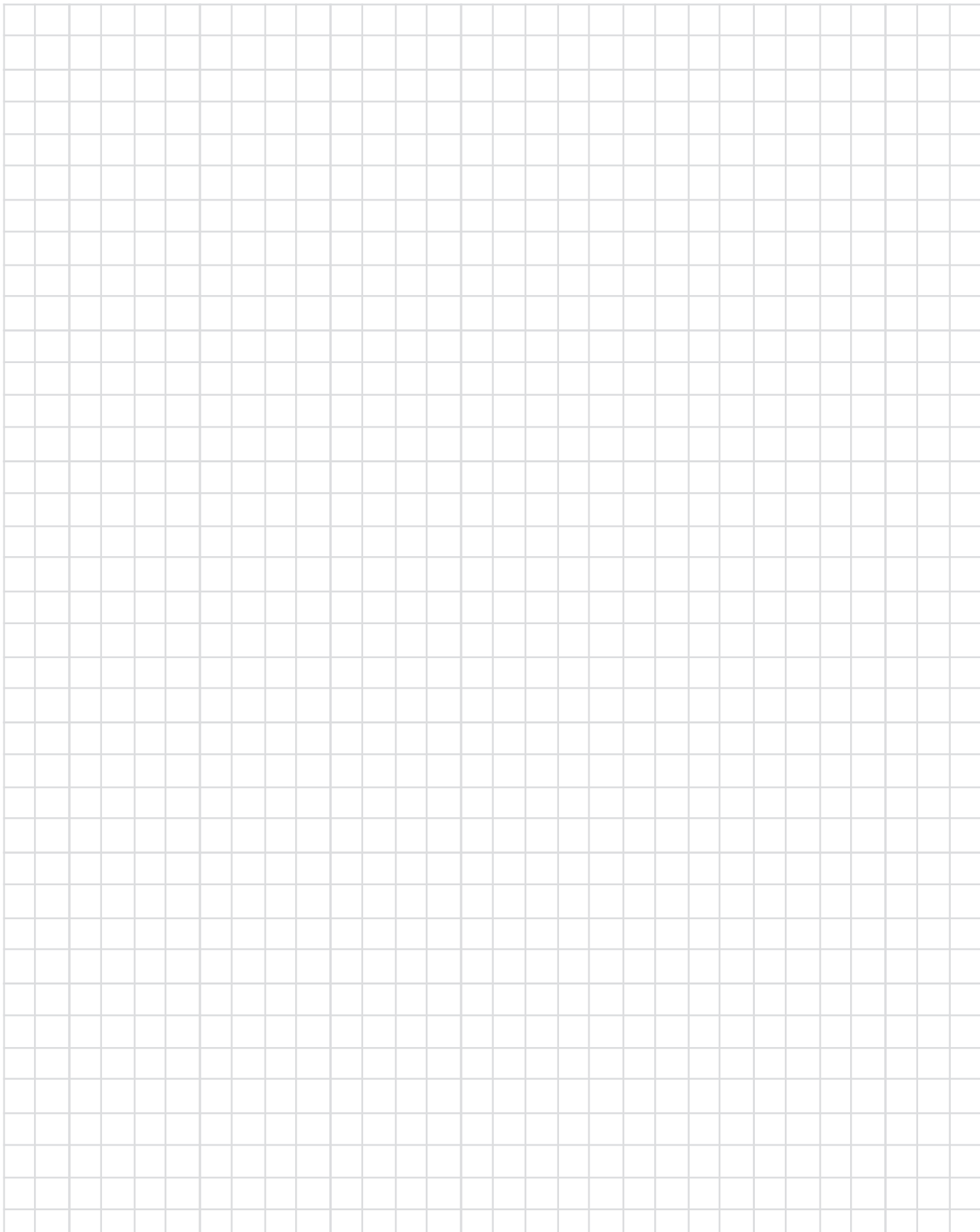





Audio Specifications

Output Level

2.0V_{rms}

Output Impedance

200 ohms

Audio Frequency Response

2Hz to 22,000Hz ±1dB

Signal to Noise Ratio

102dB (IHF A-Weighted)

Dynamic Range

96dB

Harmonic Distortion

0.01%

Channel Separation

95dB (1,000Hz)

Video Specifications

Signal System

NTSC/PAL

Component Video Output Level

Y Output Level 1.0V_{p-p} (75 OHM)

P_B/C_B Output Level 0.648V_{p-p} (75 OHM)

P_R/C_R Output Level 0.7V_{p-p} (75 OHM)

S-Video Y Output Level

1V_{p-p} (75 OHM)

S-Video C Output Level

0.286V_{p-p} (75 OHM) (NTSC)

Composite Video Output Level

1V_{p-p} (75 OHM)

General Specifications

Digital Output

Optical: -15dbm to -21dbm

Coaxial: 0.4V p-p to 0.6V p-p /75 ohm

Digital Signal Format

Sampling Frequency: 44.1kHz

Power Requirements

100 Volts, 50/60Hz at 60 watts

110 Volts, 50/60Hz at 60 watts

120 Volts, 50/60Hz at 60 watts

220 Volts, 50/60Hz at 60 watts

230 Volts, 50/60Hz at 60 watts

240 Volts, 50/60Hz at 60 watts

Note: Refer to the rear panel of the MS750 for the correct voltage.

Overall Dimensions

Width is 17-1/2 inches (44.45cm)

Height is 6 inches (15.24cm)

Depth is 15-7/8 inches (40.32cm)

Note: When the Disc Tray is opened, the panel clearance required in front of mounting panel is 6-3/4 inches (17.2cm).

Weight

28.1 pounds (12.8Kg) net, 44.5 pounds (20.2Kg) in shipping carton

Shipping Carton Dimensions

Width is 26-1/2 inches (67.3cm)

Depth is 24-1/4 inches (62.2cm)

Height is 11-3/4 inches (29.9cm)

Packing Instructions

In the event it is necessary to repack the equipment for shipment, the equipment must be packed exactly as shown below. It is very important that the four plastic feet are attached to the bottom of the equipment. This will ensure the proper equipment location on the bottom pad. Failure to do this will result in shipping damage.

Use the original shipping carton and interior parts only if they are all in good serviceable condition. If a shipping carton or any of the interior part(s) are needed, please call or write Customer Service Department of McIntosh Laboratory. Refer to page 4. Please see the Part List for the correct part numbers.

Quantity	Part Number	Description
1	033838	Shipping carton only
4	033837	End cap
1	033836	Inside carton only
1	033725	Top pad
1	034301	Bottom pad
4	017937	Plastic foot
4	400159	#10-32 x 3/4" screw
4	404080	#10-7/16" Flat washer

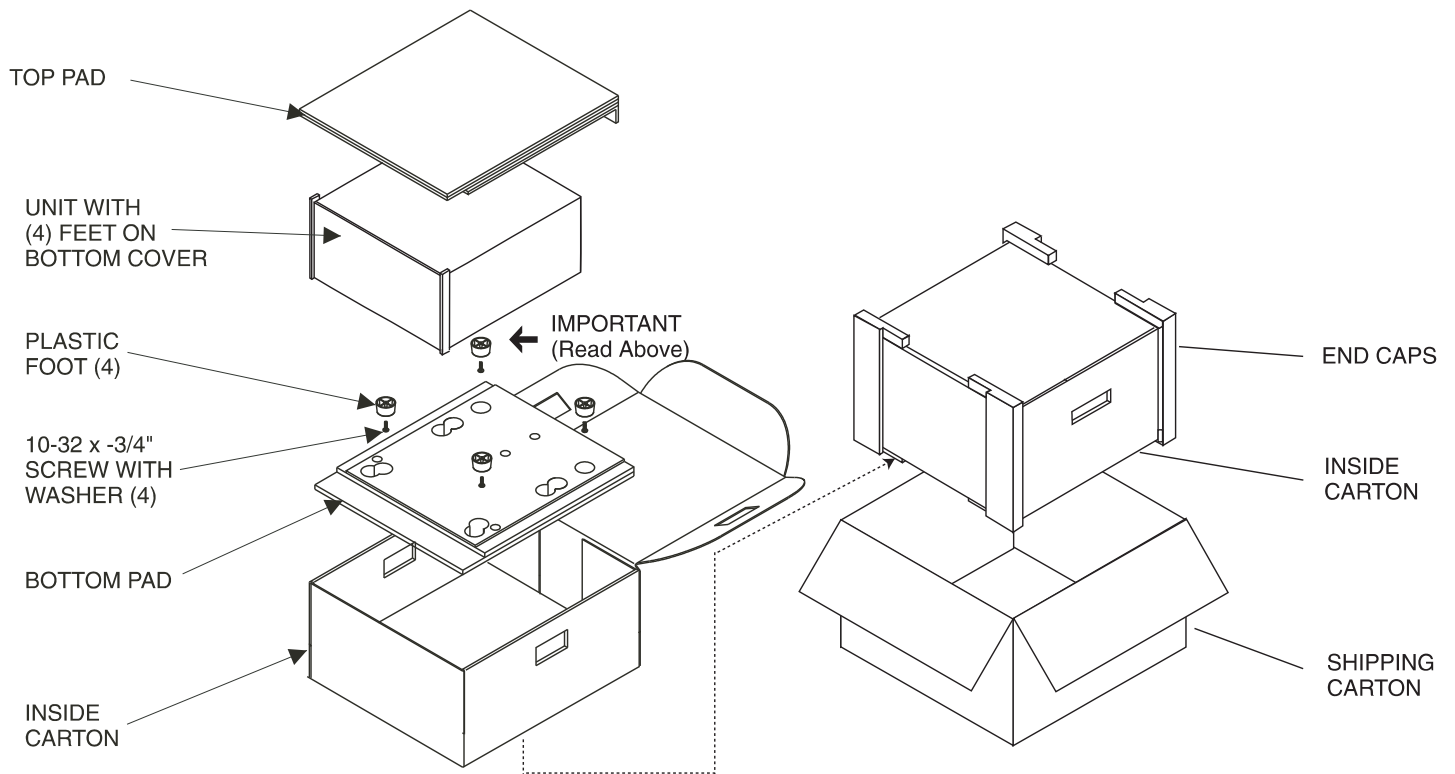



McIntosh Laboratory, Inc.
2 Chambers Street
Binghamton, NY 13903

The continuous improvement of its products is the policy of McIntosh Laboratory Incorporated who reserves the right to improve design without notice.
Printed in the U.S.A.

McIntosh Part No. 04101900